

2017 AIAA Student Design Competition

# HUMAN SPACEFLIGHT: PHOBOS BASE

Timothy Bishop

Victor Kitmanyen

Thomas Lagarde

Zachary Taylor

Faculty Advisor: Olga Bannova, Ph.D.

Sasakawa International Center for Space Architecture (SICSA)

Cullen College of Engineering, University of Houston

Houston, Texas, USA



## Signature Page



---

Timothy Bishop  
Project Manager  
AIAA #: 677333



---

Victor Kitmanyen  
Microgravity Countermeasures Architect  
AIAA #: 819885



---

Zachary Taylor  
Space Architect  
AIAA #: 819283

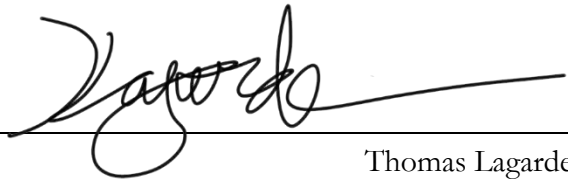

---

Thomas Lagarde  
RECLSS Architect  
AIAA #: 819864



---

Dr. Olga Bannova  
Faculty & Project Advisor

## Table of Contents

<b>LIST OF FIGURES</b>	<b>6</b>
<b>ACRONYMS</b>	<b>8</b>
<b>1.0 ABSTRACT</b>	<b>9</b>
<b>2.0 PROJECT INTRODUCTION</b>	<b>10</b>
<b>3.0 REQUIREMENTS: ANALYSIS AND INTERPRETATION</b>	<b>11</b>
3.1 SITE	11
3.2 SPACEFLIGHT ASSUMPTIONS	11
3.3 CREW & CREW PROTECTION	11
3.4 ACCESSIBILITY	12
3.5 ENVIRONMENTAL PROTECTION	12
3.6 PAYLOAD DELIVERY	12
3.7 EXTERNAL ENVIRONMENT	12
3.8 LIFE SUPPORT	13
3.9 LIFE SCIENCES PROVISIONS	13
<b>4.0 CONCEPT KEY FEATURES</b>	<b>14</b>
4.1 ARCHITECTURE	14
4.2 ENGINEERING SYSTEMS	15
4.3 INFRASTRUCTURE	16
4.4 LIFE SCIENCE PROVISIONS	16
4.5 REGENERATIVE ECLSS	18
4.6 TIMELINES	18
4.7 TRAJECTORIES	22
<b>5.0 INTERPLANETARY TRANSFER</b>	<b>23</b>
5.1 EARTH TO MARS SYSTEM	23
5.2 APPROACH TO PHOBOS	23
5.3 ARRIVAL AT PHOBOS	24
5.4 DELIVERY AND PAYLOAD LANDING	25
<b>6.0 BASE ASSEMBLY &amp; CONSTRUCTION</b>	<b>26</b>
<b>7.0 SPACE ARCHITECTURE OF PHARI BASE</b>	<b>30</b>
7.1 AIRLOCKS	30
7.2 CONNECTORS	30
7.3 MODULES	30
7.4 NODES	35
7.5 STRUCTURES & UTILITY ROUTING	36
<b>8.0 DESIGNS &amp; ESTIMATES</b>	<b>40</b>
8.1 SUBSYSTEM DESIGN AND SELECTION	40
8.2 RECLSS ENGINEERING SCHEMATICS	40
8.2.1 Greenhouse assembly and construction	46

8.2.2 <i>Greenhouse operation</i>	48
8.3 MASS FLOW ESTIMATES	51
8.4 RESUPPLY ESTIMATES	52
8.5 ISRU ESTIMATES	52
<b>9.0 LIFE SCIENCE COUNTERMEASURES</b>	<b>54</b>
9.1 MICROGRAVITY	54
9.2 RADIATION	63
9.3 DUST & CONTAMINANTS	65
9.4 PLANETARY PROTECTION	65
<b>10.0 ARRIVAL OF CREW</b>	<b>67</b>
10.1 CREW TRANSFER FROM INTERPLANETARY VEHICLE (IPV)	67
10.2 PROCESS OF BASE ACTIVATION AND VERIFICATION	67
10.3 FURTHER ASSEMBLY, CONSTRUCTION, OUTFITTING	69
<b>11.0 CONCEPT OF OPERATIONS</b>	<b>70</b>
11.1 COMPLETED BASE	70
11.2 UNIQUE SYSTEMS	71
11.2.1 <i>Shuttle</i>	71
11.2.2 <i>Rover</i>	71
11.2.3 <i>Robotic arm</i>	71
11.2.4 <i>Surgical robot</i>	71
11.2.5 <i>Geodesic dome</i>	72
11.3 SPACE PORT	72
<b>12.0 FUTURE BASE EXPANSION</b>	<b>73</b>
<b>13.0 CRITICAL TECHNOLOGY TRL</b>	<b>74</b>
<b>14.0 CONCLUSION</b>	<b>75</b>
<b>15.0 REFERENCES</b>	<b>76</b>

## List of Figures

Figure 1: Inside Phari Base .....	14
Figure 2: Truss Landing Assembly (TLA) .....	19
Figure 3: Timeline of precursor Phobos missions and Phari assembly in LEO [Years 1 – 3] .....	20
Figure 4: Timeline of Phari assembly in LEO and prep for Phobos [Years 4 – 6].....	21
Figure 5: Representation of Phari Trajectories with VASIMR .....	22
Figure 6: Representation of Phari Trajectories with VASIMR .....	29
Figure 7: CM & Galley Renderings.....	31
Figure 8: Crew Hab Renderings .....	32
Figure 9: Medical Bay, Airlock Bay & SM Renderings .....	33
Figure 10: Power Module Renderings .....	34
Figure 11: Spaceport & Artificial Gravity Module Renderings .....	34
Figure 12: Airlock Bay .....	35
Figure 13: Truss Configurations .....	38
Figure 14: Chosen Truss Design.....	39
Figure 15: Examples of Lighting .....	40
Figure 16: Effects of zero gravity on plants .....	41
Figure 17: Concept of nourishment for plants.....	42
Figure 18: Light analysis .....	43
Figure 19: Phari Base circulation diagram.....	46
Figure 20: Rotating Garden.....	47
Figure 21: Collapsible Compost Bags .....	48
Figure 22: Arrangement of Greenhouse equipment .....	50
Figure 23: Fuel Depot .....	53
Figure 24: Comfort chart for a rotational AG environment depicting the relationships between radius, angular velocity, and corresponding g-level. Areas of green are likely areas of comfort; areas of yellow or orange may be areas of comfort or discomfort, and area.....	55
Figure 25: Shooting a basketball in AG gradients of different radius lengths. A successful shot on Earth is shown dotted for referenc.....	56
Figure 26: Module 2 parked underneath the spaceport, while crew arrive at the spaceport via pressurized shuttle.....	59
Figure 27: Shuttle docked; Module 1 parked underneath the spaceport.....	60
Figure 28: Top view of Module 1. (Note: each module is designed to accommodate up to 4 crewmembers. However, more than 4 crewmembers are depicted here and in the following figures to demonstrate their actions at each functional area).....	60
Figure 29: Bottom view of Module 1 .....	61
Figure 30: Forward view of Module 1 .....	61
Figure 31: Aft view of Module 1 .....	62
Figure 32: The restroom installed on both Module 1 and Module 2 feature a detachable showerhead so as to allow crewmembers complete control of the flow of water in response to the unnatural Coriolis effects.....	63
Figure 33: Yellow border showing the extent of the safe room .....	64
Figure 34: Ames Research Center .....	65

Figure 35: Operational Phari base.....70  
Figure 36: Possible expansion of the base.....73

## Acronyms

AG	Artificial gravity
CHM	Crew Habitat Module
CM	Command Module
ConOps	Concept of Operations
ECLSS	Environmental Control Life Support System
EVA	Extravehicular activity
FIT	Failure Investigation Team
GCR	Galactic Cosmic Radiation
GPS	Global Positioning Satellite
IPV	Interplanetary Vehicle
ISP	Specific Impulse
ISS	International Space Station
LEO	Low Earth Orbit
PM	Power Module
RECLSS	Regenerative Environmental Control Life Support System
SM	Support Module
SPE	Solar Particle Event
TLA	Truss Landing Assembly
VASIMR	Variable Specific Impulse Magnetoplasma Rocket
SLS	Space Launch System



## 1.0 Abstract

With 50 million kilometers and a 20-minute communication delay separating Mars explorers from Earth's resources and support, human missions to the red planet will be characterized by an unprecedented amount of autonomy and independence. In order to alleviate the logistics within Mars orbit, the SICSA team at the University of Houston is proposing a unique design for a permanently crewed base on the surface of Phobos. The baseline for a design approach was driven by analysis of habitability requirements, Phobos environmental conditions and capabilities of known launch systems. Those drivers called for researching and evaluating emerging technologies and their applicability to mission goals and objectives. Design concepts are evaluated for their safety provisions, emergency response strategies, and evolutionary growth potentials. After evaluations' analysis, trade studies findings are incorporated into the final concept development.

The team chose crew safety, health maintenance and operational sustainability for making critical design decisions. Trade studies reviewed zero-gravity countermeasures options, location and deployment sequence on Phobos surface, primary power sources, primary habitat structure choices, and support trusses configurations and materials. Special considerations are given to logistical re-supply missions from Earth and contingency plans that are critical for continues mission success but constrained by limitations posed by 26-month Earth-Mars synodic cycle. This design is therefore a proposal based on actual knowledge to establish a sustainable human presence in outer-space in order to facilitate human exploration of Mars and beyond.

## 2.0 Project Introduction

In order to facilitate the exploration of Mars and Beyond, the SICSA team at the University of Houston is proposing a permanent, crewed base on the surface of Phobos. Given its proximity and frequent orbit of Mars, Phobos makes for a perfect “gateway” for incoming astronauts to arrive at and prepare for a careful descent to the Martian surface. The base is located on the slopes of the large, nadir-facing Stickney Crater; it would be capable of accommodating 12 crewmembers at any given time and would include a universal spaceport, a large greenhouse, a long-radius centrifuge, and facilities for exercise, recreation, in-situ resource processing, 3D printing, mission observation, and communication with Mars. Its location on Phobos will provide protection from at least 90% of the Galactic Cosmic Rays (GCR) likely to be encountered. Furthermore, the entire base would run on energy from a localized nuclear reactor with solar panels and batteries acting as emergency power systems. This design proposal examines several key mission-planning issues, and provides concept of operations, technical specification, trade studies and conceptual designs of all major components.

The baseline for a design approach was driven by analysis of habitability requirements, Phobos environmental conditions and capabilities of known launch systems. Those drivers called for researching and evaluating emerging technologies and their applicability to mission goals and objectives. Design concepts evaluation of their safety provisions and emergency response strategies along with evolutionary growth potentials, defined design evolution and the final concept development.

All base elements, systems and structures are designed for Earth launch, providing two major design choices: mass and volume requirements of the future NASA Space Launch System 10-meter fairing diameter, and 5-meter diameter fairing and payload requirements of Atlas V/Delta IV launch systems.

The feasibility of a sustainable human outpost is the goal of this project and it aims to show that such a mission is possible with actual and in-development technology.

## **3.0 Requirements: Analysis and Interpretation**

### **3.1 Site**

While the landing site on Phobos, Stickney Crater, is the designated site for the base, the crater is very large and an in-depth analysis must be made to determine the properties of the crater. Properties such as elevation, dust depth and surface density will factor into the specific target location for Phari Base. Furthermore, research into the orbital mechanics of the Mars-Phobos system is crucial in determining not only sunlight exposure but also radiation protection from solar and galactic radiation. To meet all the requirements of crew protection from radiation, micro-meteorite impacts and dust mitigation, precursor robotic and crewed observation missions for selecting the optimal location are absolutely crucial to the success of the surface base establishing mission.

### **3.2 Spaceflight Assumptions**

The crew at Phari Base must be prepared to receive both crew and supplies from a multitude spacecraft that may arrive at almost any time to Phobos. This is analogous to the crews onboard the ISS where there are multiple supply visiting vehicles and crew transfer vehicles that dock with the ISS on a regular basis. The same can be assumed for Phari Base, where visiting vehicles carrying supplies will be sent periodically and may use any class of mission that is the most efficient method of delivery. Mars bound crews may arrive less frequently, however, since the base is assumed to expand its capabilities at some point in the future, crews can expect more traffic to flow through the base and thus should be prepared for these operations.

### **3.3 Crew & Crew Protection**

The base must be able to support a crew size of 12 at any point in time. This constrains the minimum required size of the overall base. Also, due to ConOps such as maintenance, repair, science and EVA, the base must be even larger in order to accommodate the multitude of functions and operations that the crew will be performing each day. Furthermore, the base design should provide evolutionary growth potentials, which includes accommodations for double, triple, even quadruple the crew size in the future.

### 3.4 Accessibility

All areas of the base must be easily accessible, meaning a crew member must be able to traverse from one section of Phari base to another with little effort in a minimum amount of time. Designing to these specifications means that there should be clear and open pathways between areas and ingress / egress must be fluid and simple. Circulation with dual egress capabilities are also crucial for the crew safety in emergency situations.

### 3.5 Environmental Protection

Environmental protection provides many challenges for the crew. Radiation is the number one concern for the crew as extreme levels of radiation will cause the crew to become sick and they will be unable to perform the base duties. Design considerations must be made to ensure the highest level of protection for the crew. Furthermore, SPE could be potentially dangerous for the crew, exposing them to higher than normal levels of radiation. Countermeasures must be put in place to wait out solar storms. Micro-meteorite impacts are less of a probable threat, however, the danger still exists.<sup>[1]</sup> Phobos did not get craters on its surface without being subjected to meteorite impacts. The base modules' structural design must be able to stand up to virtually any impact caused by a micro-meteorite.

### 3.6 Payload delivery

The base relies on a steady stream of payloads from Earth to remain operational. This above all else requires logistics planning and integration engineering. It has to be taken into considerations that the base assembly and logistical re-supply missions are constrained by limitations posed by a 26-month Earth-Mars synodic cycle.

### 3.7 External environment

Phari Base must interface with Phobos in a variety of methods if it is to function at its optimal performance. These functions range from base installation to ISRU technologies to exploration operations.

The design and function of the base must therefore be able to incorporate all these features while also keeping interaction with the surface to a minimum due to the high levels of dust.

### 3.8 Life support

The RECLSS and ECLSS systems must be able to support 12 people at any given time and be able to grow at least 50% of the food that is consumed by the crew. While growing food is an essential system, redundancies will have to be put in place in order to ensure the crew have enough dry food in case the growable food production fails. Much of what the ISS ECLSS does is be able to recycle 93% of the water from the environment, therefore calculating how much potable water supply is needed if a supply mission is scrubbed is paramount to ensuring the crew's survival.<sup>[2]</sup> Based on estimates by NASA, a human needs 1.62 kilograms of water per day, we will therefore need a water tank that can hold up to 21 tons of water.<sup>[3]</sup>

### 3.9 Life sciences provisions

The base must have the facilities to aid crews in muscular and bone recovery from the effects of micro-gravity. Also, the base must be able to reduce the radiation exposure of the crew down to manageable levels where they will not succumb to radiation poisoning or development of long term damaging ailments. Furthermore, dust will present itself as one of the major problems while on Phobos; the Apollo crews had a tough time with the extremely coarse Moon dust and Phobos dust will be no exception. Designs that minimize the amount of dust content must be utilized. Finally, there must be mechanisms in place that prevent dust or other extra-terrestrial contaminants from entering the interior of Phari Base.

## 4.0 Concept Key Features

### 4.1 Architecture

The arrangement of the base on vertical axis provides for a limitation in structural support. Circulation is also eased as one circular core allows the crew to visit all the different parts of the station. This configuration also simplifies systems networks for water, air, and electrical piping go down a centralized, easily accessed, corridor. This also makes habitation easy for zero gravity conditions, such as it would be during transit time. Figure 1 below shows the sequential order of the module and how one transverses from one to another.

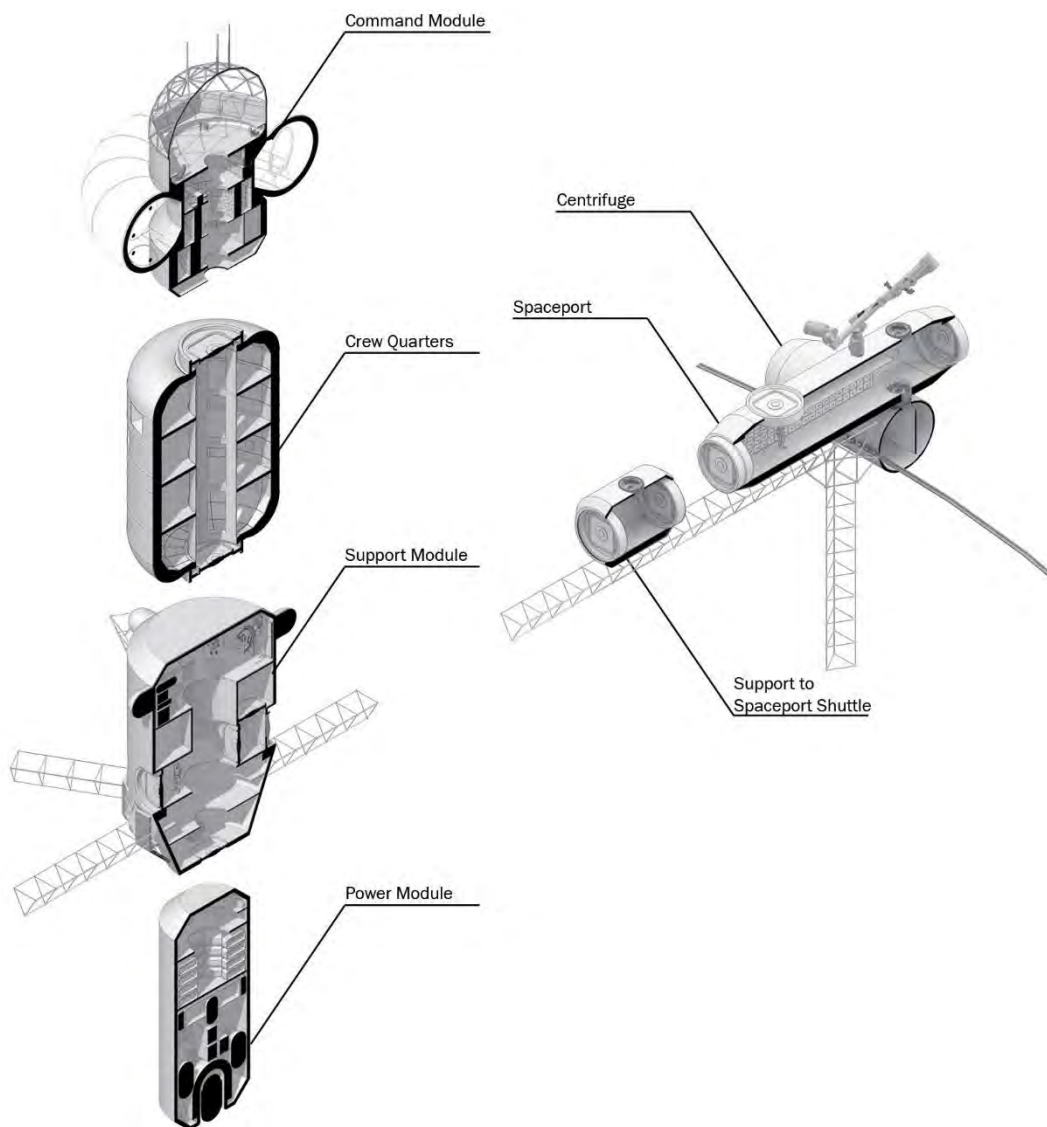

Figure 1: Inside Phari Base

## 4.2 Engineering Systems

Through application of unique engineering and design decisions, the SICSA team addresses many of the issues that Phari base will be facing, such as dust mitigation, assembly complexity and crew radiation protection. The team proposes approaches that can handle multiple problems with a single solution. The first decision is assembling the base in LEO and subsequently transporting the entire base to Phobos using the VASIMR engine. Second is the use of polyethylene to create a safe space for the crew in the event that a solar storm hits the base. Third, the unique truss design utilizes state-of-the-art carbon fiber technology to provide the infrastructure to support current and future modules, while also keeping the entire base above the Phobos surface to minimize dust interaction. Finally, the truss assembly allows for modules to run on rails and provide a means of transport to other parts of the base without the need for EVA suits.

The assembly will begin in LEO. It will begin with the launch of the SM, which houses the ECLSS system and has its own temporary solar power. The assembly continues by adding the CHM next, which is a Bigelow B330. Then the CM is attached to the Crew Habitat Module and lastly the PM is attached to the SM. Once crews outfit the interior of the base and verify all the systems are 100% operational, a separate module that houses a small nuclear reactor and the VASIMR engine will attach to the Power Module and send Phari base to Phobos. This approach is unique in the sense that by utilizing the very best in propulsion technology, the base can be assembled in fewer launches which saves the space program money and minimizes the assembly time.

Radiation protection is always a priority system in any space habitat environment. The priority increases when there is a solar storm that is sweeping through the solar system. Due to the unpredictability of these storms, the crew must be ready to travel to the emergency shelter with a given sense of urgency. The outer walls surrounding the galley and hygiene room have been outfitted with polyethylene bricks to provide the extra radiation protection required in the event of additional radiation exposure. Polyethylene has been shown to reduce the exposure of gamma rays as much as or more than lead.<sup>[4]</sup> While this does add mass to the Command Module, the price is worth it.

The TLA is a one of a kind system that utilizes the tensile strength of carbon fiber to handle the forces and stress of the base on Phobos. Carbon fiber is both stronger and lighter than most materials; furthermore it has the ability to remember its shape. This is especially useful for packing and unpacking the truss into the confined space of a payload fairing inside of rocket. The TLA was designed to sit tens of meters above the dusty surface of Phobos, allowing for minimal dust interaction and providing an anchor to Phobos.

The TLA supports transportation modules that run along the horizontal trusses from the SM to the Spaceport. The transportation modules stay pressurized at all times and are either attached to the SM or the Spaceport. This eliminates the need to EVA to other outer modules or to go through the hassle of pressurize / depressurize compartments within modules. These transportation modules also allow large quantities of cargo to be transported to and from the Spaceport quickly and safely.

### 4.3 Infrastructure

The infrastructure for Phari Base is designed with expandability in mind. We understand that in the future, this base will act as the gateway to Mars; with more interplanetary traffic there is bound to be more people arriving and departing from Phari Base. Our unique hexagonal truss design allows for large-scale expansion projects once the base begins to see higher traffic volumes coming through its airlocks. To power these expansion, a nonproliferation nuclear power generator has been designed and it utilizes designs similar to the already existing molten salt nuclear reactors which run on thorium, a non fissile radioactive and highly abundant element. Furthermore, the power generation capabilities are built to withstand loads of up to 2 MWe to facilitate the myriad of operations Phari Base is capable of supporting now and in the future. Finally, we integrated a large number of hatches into the original design which allows for the smoothest integration of additional hardware when it is eventually needed.

### 4.4 Life Science Provisions

The SICSA team has developed solutions that preserve the health of the crew in the areas of micro-gravity, radiation exposure, dust and contaminants, and micro-meteorites.



To counter the effects of microgravity the base employs two modules running along a rail track around the perimeter of Phari Base, allowing centrifugal forces to act on the crews inside each module, and thereby creating artificial gravity conditions that will mitigate and balance the symptoms of zero-G exposure. One module is dedicated to exercise activity while the other is used for VR mission training. Together, these modules will allow the crew to recondition their bodies and prepare for the tasks ahead.

Radiation protection comes in two forms; the first is the location of Phari base and second is the engineering of the modules themselves. Housing the base inside of crater offers up to 90% of radiation protection from SPEs and GCR. Furthermore, it will be advised to the crew to spend their time in the CHM as it is constructed from non-metallic materials which decreases the changes of particles interacting with the module walls.<sup>[5]</sup> This in turn decreases the probability of collisions between high energy particles and the module surfaces as such collisions with metal surfaces tend to produce a shower of high energy particles.

Dust and contaminants are controlled by the position of the base above the dust and also quarantine procedures that stop extra-terrestrial substances from entering the facility unexamined. The base will be at least 70 meters above the surface of the dust (assuming a dust height of 20 meters), which will prevent large plumes of dust from getting near the bases outer walls. The astrobiology lab will have its own double hatch that will keep the amount of contamination to a minimum. Crews coming from the surface will enter straight into the astrobiology lab with their samples. There will also be decontamination equipment through the spaces exposed to extra-terrestrial particles in order to keep the facility as safe as possible.

Micro-meteorite or small particle collisions will be much less frequent than on the ISS. However, Phobos is littered with craters so it is only a matter of time before another meteorite strikes somewhere on the surface. The modules of Phari base as designed in much the same way as the modules of the ISS, which consists of whipple shielding techniques. These techniques will be applied to the tin can modules (SM, CM, PM). Bigelow has suggested that the multi layer Kevlar used in their inflatable modules is more resistant to impacts than traditional modules are. As such, the crew will be adequately protected no matter where they are on base.

## 4.5 Regenerative ECLSS

The SICSA team is utilizing a non-traditional torus shape inflatable structure that is attached to the CM. This inflatable will have better airflow and will have a highly productive greenhouse that is designed to produce the required more than 50% of the crews daily food intake (35 days to produce edible plants) and also recycle all of the Oxygen. It has storage space to utilize human waste for compost and fertilization while the captured CO<sub>2</sub> from the ECLSS systems allows the plants to grow faster. Finally, specific lighting configurations to allow plants to grow more efficiently, the lighting is kept on all the time.

## 4.6 Timelines

The entire Phari Base construction mission has multiple timelines all running in parallel in order to use time most efficiently. There is a pre-requisite data gathering mission that must be accomplished before the base can begin its construction in LEO; a probe is intended to intimately study the surface of Phobos. Secondly, GPS satellite missions will follow which will be inserted into orbit around Phobos. These satellites will serve to provide telemetry whenever something lands on or near the surface of Phobos and is a crucial component in the landing logistics of Phari Base. Third, the Truss Landing Assembly will depart for Phobos and attempt to make a successful autonomous landing on the surface. If successful, the TLA will serve as the docking node for Phari Base. Finally, the base itself will be constructed in LEO with crews outfitting the interior of each module with equipment and verifying all the systems and subsystems. Repairs and on-base spares will be assessed and reassessed to ensure the highest level of redundancy while in transit and in full operation on Phobos.

Assembly and base verification in LEO affords certain benefits over conducting similar operations near Phobos remotely. These benefits are:

- Better control of remote robotic operations
- Opportunity to re-deliver equipment to Earth in the event of a malfunction
- Operations check of all systems prior to departure
- Possibility of adjustments and upgrades during the assembly operations

- Access to Earth resources during troubleshooting events
- Better telemetry of module integration

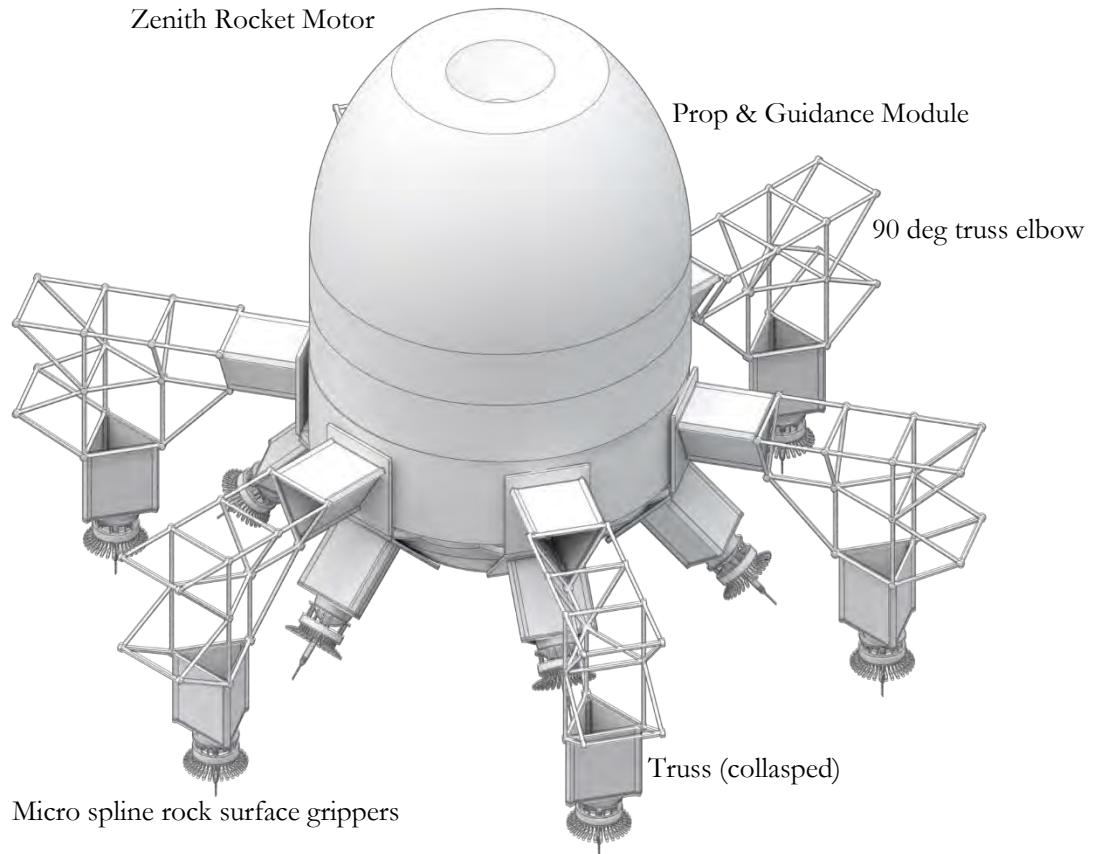

Figure 2: Truss Landing Assembly (TLA)













YEAR	1				2				3			
Quarter	Q1	Q2	Q3	Q4	Q1	Q2	Q3	Q4	Q1	Q2	Q3	Q4
<b>Crew Rotation</b>						Crew #1 Crew #2 Crew #3		Crew #1 Crew #2 Crew #3		Crew #1 Crew #2 Crew #3		Crew #1 Crew #2 Crew #3
							Crew #4 Crew #5 Crew #6		Crew #4 Crew #5 Crew #6		Crew #4 Crew #5 Crew #6	
<b>Ground Ops</b>	Supervise orbit insertion	Supervise probe operations	Position into orbit	Berth with Support Module						Supervise Phobos Landing		
			Deploy Solar Arrays									
<b>Crew Ops</b>					Unpack supplies / Test equipment / Repair / Maintenance tasks / Inventory items							
					ECLSS fitting			Grow plants				
					Ops Check facility					Conduct science		
<b>Cargo</b>	4 x Phobos GPS	Phobos Reconnaissance Probe	Support Module	Crew Habitat Module	Crew & Supplies	Crew & Supplies	Crew & Supplies	Crew & Supplies	Crew & Supplies	Truss Landing Assembly / Crew & Supplies	Crew & Supplies	
<b>Target Location</b>	Phobos	Phobos	LEO	LEO	LEO	LEO	LEO	LEO	LEO	Phobos	LEO	LEO
<b>Cargo Vehicles</b>												
<b>Crew Vehicles</b>												
	Falcon heavy	Falcon Heavy	SLS-B2	Atlas V	Dragon Crew	Dragon Crew	Dragon Crew	Dragon Crew	Dragon Crew	Dragon Crew	Dragon Crew	Dragon Crew

Figure 3: Timeline of precursor Phobos missions and Phari assembly in LEO [Years 1 – 3]

















YEAR	4				5				6			
Quarter	Q1	Q2	Q3	Q4	Q1	Q2	Q3	Q4	Q1	Q2	Q3	Q4
<b>Crew Rotation</b>		Crew #1 Crew #2 Crew #3		Crew #1 Crew #2 Crew #3		Crew #1 Crew #2 Crew #3		Crew #1 Crew #2 Crew #3		Crew #1 Crew #2 Crew #3		
	Crew #4 Crew #5 Crew #6		Crew #4 Crew #5 Crew #6		Crew #4 Crew #5 Crew #6		Crew #4 Crew #5 Crew #6		Crew #4 Crew #5 Crew #6			
<b>Ground Ops</b>	Berth Support Module with Command Module				Berth Support Module with Power Module				Berth Power Module with VASIMR Module	Fuel VASIMR Module	Begin spiral transfer to L1	Dock with crew transfer vehicle
<b>Crew Ops</b>	Unpack supplies / Test equipment / Repair / Maintenance tasks / Inventory items / Maintain plant production								Ops Check Facility			
	ECLSS fitting		Conduct science						Phobos departure Prep			
	Berth Support Module with Command Module	Ops Check facility			Berth Support Module with Power Module	Ops Check facility			Berth Power Module with VASIMR Module	Fuel VASIMR Module		Dock with Phari Base
<b>Cargo</b>	Command Module Crew & Supplies	Crew & Supplies	Crew & Supplies	Crew & Supplies	Power Module	Crew & Supplies	Crew & Supplies	Crew & Supplies	VASIMR Module	VASIMR Fuel Crew & Supplies		Set destination Phobos
<b>Target Location</b>	LEO	LEO	LEO	LEO	LEO	LEO	LEO	LEO	LEO	LEO	L1	L1
<b>Cargo Vehicles</b>												
<b>Crew Vehicles</b>												
	Dragon Crew	Dragon Crew	Dragon Crew	Dragon Crew	Dragon Crew	Dragon Crew	Dragon Crew	Dragon Crew	Dragon Crew	Dragon Crew		Dragon Crew

Figure 4: Timeline of Phari assembly in LEO and prep for Phobos [Years 4 – 6]

## 4.7 Trajectories

One of the unique aspects of the Phari base mission is the ability to construct and assemble a fully operational multi-ton facility and transport the entire structure to another destination. This is all made possible through the advances in propulsion technology. Phari base will only be utilizing the very latest in propulsion technology, the VASIMR engine, built by the Ad Astra Rocket company. VASIMR is unique in the sense that it use electromagnetism to accelerate its propellant at very high velocities, achieving ISP's as high as 12,000 sec (although, it has been proposed ISP's as high as 30,000 sec are obtainable)<sup>[6]</sup>

The trajectory path of Phari base will begin in LEO, then conduct a spiral orbit outward through the Van Allen Belts to Lagrange Point 1, in order to build up the required delta v. The crew will be waiting for Phari base and will dock with the facility. It will then carry on to Phobos on a Hohmann transfer where it will insert itself into the same orbital plane as Phobos around Mars; Phari base's orbit will be higher than Phobos. It will then slowly descend to Stickney Crater, the crew utilizing the full capabilities of the manueavring controls. The base will finally mate with the TLA's docking collar and lock into place.

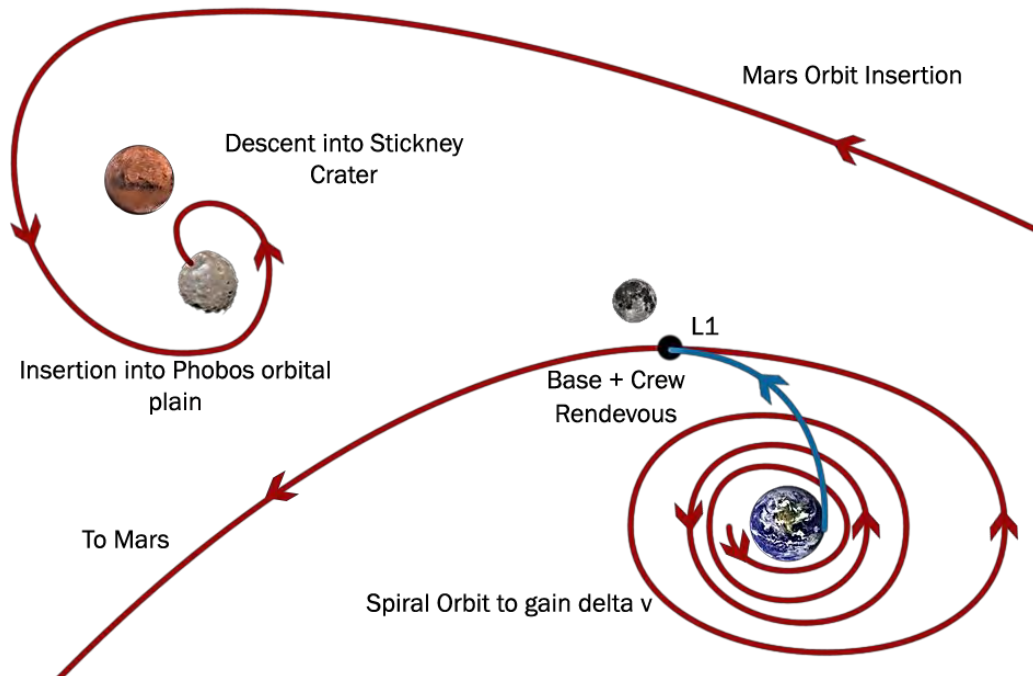

Figure 5: Representation of Phari Trajectories with VASIMR

## 5.0 Interplanetary Transfer

### 5.1 Earth to Mars System

The transfer of the Phari Base infrastructure will happen in two stages. The first stage will be to launch the truss assembly to Phobos. The rationale behind this activity is to ensure Phari Base has an established structure on Phobos that is secured to the bedrock. Furthermore, the truss assembly itself is cheap relative to the entire base and will only require one SLS Block 2 launch. This makes the truss assembly expendable in the event the system fails; if that were to happen, telemetry would be sent back to ground control in order to engineer a more robust system. Such measures are justifiable considering how unpredictable Phobos is, even with reconnaissance probe mapping the surface..

Once the base assembly is deemed complete for transit purposes, the transit of Phari Base will begin with a long duration burn around the Earth from LEO to L1, in order to build up to the  $\Delta V$ . During this time the VASIMR engines will be using minimal thrust to conserve fuel. A separate crewed mission to L1 will occur in conjunction with the base transit mission LEO to L1. This is to reduce the crew's exposure to high energy particles trapped in the Van Allen belts.

### 5.2 Approach to Phobos

During the first mission the TLA will perform correcting maneuvers on transit to Phobos so it can seamlessly interject itself into the same inclination as the martian moon as it orbits Mars. Once in orbit around Mars, the TLA will begin a series of burns to descend to Phobos, where it will orbit Phobos for a brief period before beginning its final descent to the surface. With the aid of GPS network already in orbit around Phobos, the whole landing and anchoring will be done robotically.

When the TLA reaches a predetermined (cannot be determined until actual Phobos telemetry is received) altitude, the nadir thruster will fire in short bursts to slow the descent of the TLA down to centimeters per second velocities. Once contact has been made with the regolith, the zenith thruster will begin to fire to produce a force into the regolith. Due to the micro-gravity conditions on Phobos, the regolith is assumed to

be extremely loose and uncompacted. There will be very little reaction force given by the regolith which enables the TLA grippers to make a smooth transition to the bedrock surface.

Sensors on the feet will indicate when sufficient contact has been made with the surface and the micro splines will deploy and retract to grip the porous Phobos surface, while the zenith thruster will continue to fire. Once the micro splines are secured and locked the zenith thruster will shut down and drilling will commence. The drill bits on the TLA feet are designed to drill into the bedrock and stay there. This provides two anchoring systems, the locked micro splines and the drill bits. After each TLA foot has successfully drilled into the Phobos surface, the TLA module will detach from the TLA and fire its nadir thruster in order to make room for Phari Base.

### 5.3 Arrival at Phobos

With the TLA already in place it is time for Phari base to approach Phobos. The crew on board will be controlling the descent along with computer aided software. The base will approach Phobos in the same manner as the TLA, first injecting itself into the correct inclination as Phobos while orbiting Mars, then slowly descending into the crater. Phari Base must align itself with the TLA, there will be guide markers similar to those that are used when docking or berthing on the ISS. These visual markers will serve as the guides to properly align the docking/berthing ports on the side of Phari Base with the trusses extending horizontally outward.

The VASIMR engine will be used to slow the descent of the base, while gyroscopes will be used to control the attitude of the base. The TLA houses a smooth docking collar that allows the base mate directly with the assembly. The crew will sit in the CM and will monitor and control the decent with the aid of the Phari base computer. The GPS satellites will provide feedback on the precise location of the base during the decent, ensuring the crew is able to keep the base within the tight tolerances for landing. The gravity of Phobos will ensure the base stays in its place, however just as a precaution locks will be installed and utilized for secure the base to the TLA.



## 5.4 Delivery and Payload Landing

Payloads will dock or berth with the Spaceport from above. The Spaceport is capable of supporting up to three vehicles at any one time. There will be a robotic arm to assist with berthing. There are multiple ports for visiting vehicles, whether they are coming in from Earth or Mars. Due to the size of the Spaceport, the IPVs will be limited in their size.

## 6.0 Base Assembly & Construction

### Assembly Location

The location of Phari Base assembly is the most important part of the mission because without a rigorous assembly plan the base will suffer setbacks from scheduling delays and the forever increasing costs of space flight. Based on the experience gained from the ISS program office, the frequency in which equipment breaks, malfunctions or produces anomalies have to be taken into considerations. With this in mind, constructing a new base bound for Phobos comes down to these important factors: time and money. Although we will not go into detail about the hypotheticals of how much a base such as Phari Base might cost, we can assume that the base will be under a government-funded program that is sponsored by international partners. Saving time will save money and the justification for spending more money is very difficult to achieve in the political arena. The below table outlines the criteria and location:

	<b>LEO</b>	<b>GTO</b>	<b>Mars Orbit</b>
Module Transit Time	minutes	days	months
Upload/Download time	seconds	seconds	minutes
Contingency operations	high	medium	low
Mass:Fuel Ratio <sup>[7]</sup>	1:24	1:66	1:136

Table 1: Assembly location trade study

The trade study showed that LEO is the best assembly location due to a low mass to fuel ratio, short transit time, minimal communication issues and reliability for fixing systems when they break. A low mass to fuel ratio ensures the largest payloads possible to space launch. This is vital to the success of the mission as reducing the number of launches proves to save time, money and also mitigates the risk to hardware.

### Payload Launch Capabilities

There is a myriad of current and upcoming launch vehicle capable to launching very heavy payloads into orbit. Among these is the SLS, SpaceX's Falcon Heavy and Blue Origins New Glenn rocket. The criteria came down to frequency of launches and launch mass to LEO. The Falcon Heavy has the capability of

launching multiple times per year, as SpaceX has been proving the concept of reusable rockets. The Falcon Heavy will be able to lift 63 tons into LEO. <sup>[7]</sup> Blue Origins New Glenn rocket is also able to be reused up to 100 times it is reported and provides an estimated lift capability of 45 tons. <sup>[8]</sup> However, the SLS Block 2 lift capacity dwarfs these other attempts, claiming to lift an estimated 130 tons to LEO. The SLS does not have reusability capabilities, so the cost will be much greater compared with SpaceX and Blue Origin’s rockets.

That said, the decision to use the SLS as the primary launch vehicle is one of functionality. When designing a base on a moon other than our own, human factors issues began to occur. The primary concern was space, or the lack of it. Intuitively, crews that will spend years at a time on Phobos will greatly benefit from increased space. The SLS provides the largest lift capacity which brings with it the largest payload fairing size.

Figure X on page 29 shows the packing configurations of the SLS Block 2 payload fairing for each module.

### Module Mass Estimates

The tin can type modules (CM, SM, PM) had their masses estimated using one of the ISS modules. The Columbus module was used; it had an empty mass of 10,300 kg and has a 20cm wall gap between the exterior and interior hulls and the interior volume is 24 m<sup>3</sup>. The mass to volume ratio came out to 431 kg/ m<sup>3</sup> and this ratio was applied to the volumes of the Phari modules. The estimates are as follows:

Module	Hull Volume (m <sup>3</sup> )	Estimated Mass (tons)
Command Module	190	82
Support Module	110	47
Power Module	50	22

Table 2: Module mass estimates

The B330 mass is estimated to be 40 tons. <sup>[9]</sup> The empty mass of Phari Base is estimated to be 191 tons. It is expected that outfitting the base with food, water, equipment, spare hardware, materials and crew supplies that it will add a generous 100 extra tons to the mass. Therefore, the total projected mass for a fully outfitted Phari base in LEO is 291 tons.

## VASIMR Trajectory Discussion

As previously stated, the mass of the base in LEO is projected to be 291 tons. Chemical propulsion is not feasible in this situation if the base is to make it to Phobos. Using the rocket equation in Appendix A, assuming an ISP of 435 sec (typical for a LOX/LH2 engine) and a final mass of 291 (not accounting for the engine) and accounting for the delta v to reach Phobos (4.6 km/s from L1), the facility would need 565 tons of fuel to make the trip.

A paper by Andrew V. Ilin et al demonstrated the capabilities of VASIMR using test cases for their simulations.<sup>[6]</sup> At this point in the discussion it should be noted that the software required to run simulations using VASIMR engines are solely used by NASA, Ad Astra Rocket Company and their affiliates. Therefore, the discussion is based on what is available to the public. Andrew V. Ilin et al posited that a 12 MW nuclear power system with VASIMR could transport a 165-ton spacecraft (including rocket motor and fuel) to Mars in three months. The habitat and surrounding hardware was assumed to be 61 tons in mass.

We can extrapolate the analysis and apply our own mass to very loosely estimate the logistics of the Phobos bound transit. The actual spacecraft in Andrew V. Ilin et al's is 61 tons which is approximately five times less mass than Phari base. In their paper, they required 36 tons of propellant and 68 tons of engine hardware (radiators, fuel tanks, etc.). If a linear relationship between the variables is assumed, then approximately 520 tons of fuel and engine hardware is needed to transfer Phari base to Phobos. This is assuming 12 MW of power. The transit time would remain the same, three months, which is extremely quick given a mass this size. This would require four SLS launches to get all the required mass to LEO.

Increasing the energy out will result in decreased transit times, however, by increasing the energy output it is assumed that reducing the fuel consumption rate would lengthen the travel time. Saving fuel will enable less launches into orbit to fuel the transit. Unfortunately, this is about the extent of the VASIMR discussion as the equations used to describe the relationship between energy consumption, ISP, fuel mass, trip time, delta v and destination are not readily available.

The recommendation is to utilize VASIMR using a high-energy power source (~100 MW +), utilizing as little fuel as possible and extending the journey to 6 months, which is tolerable with crew on board.

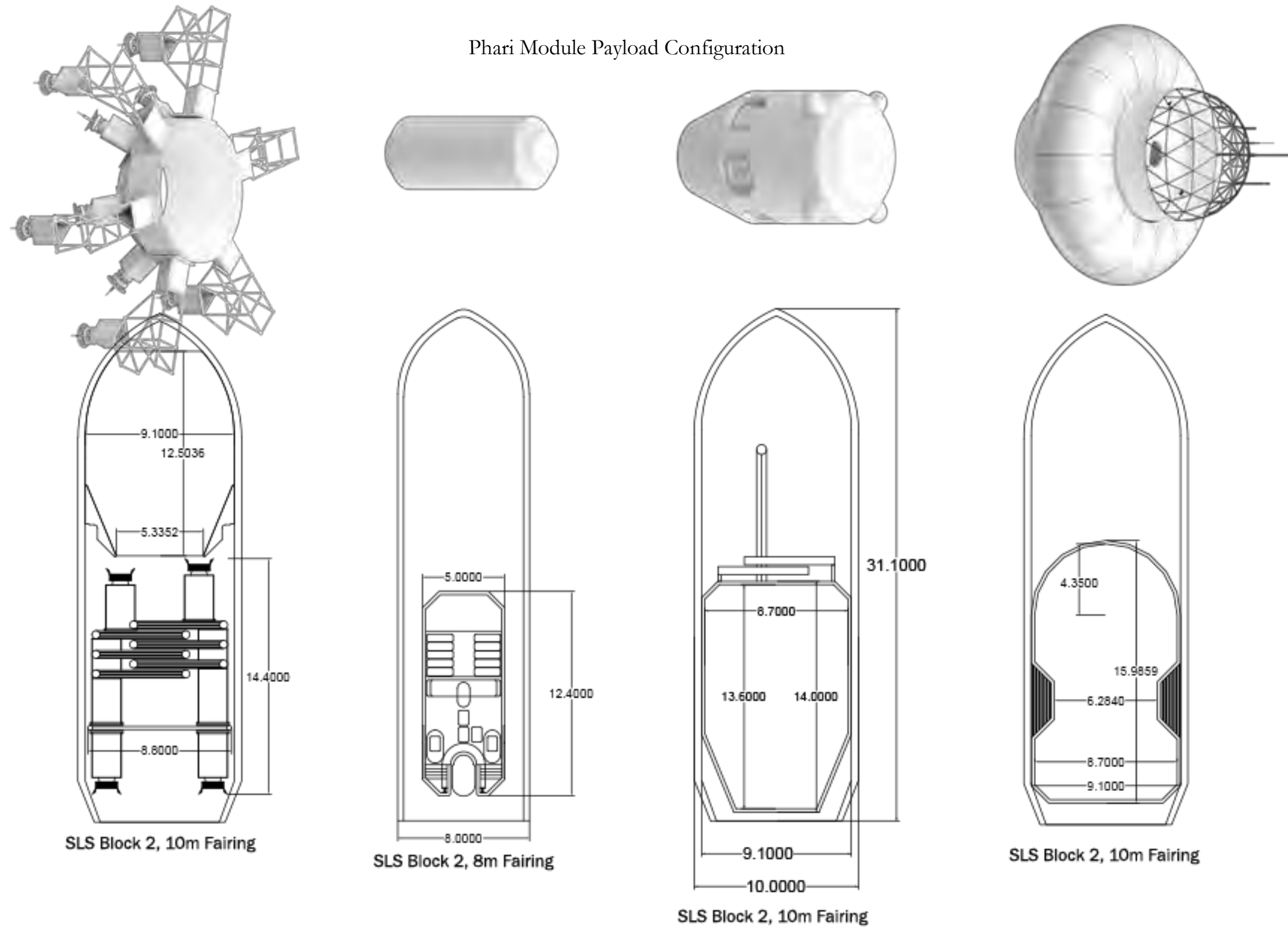

Figure 6: Representation of Phari Trajectories with VASIMR

## 7.0 Space Architecture of Phari Base

### 7.1 Airlocks

The Phari base utilizes two types of airlocks, the Common Berthing Mechanism and the International Docking Port. Other airlock types were examined below

Airlock Variants	Connection Method	Diameter	Type	Spacecraft Compatability	Key Advantages	Key Disadvantages
Common Berthing Mechanism	Berthing	940 mm	Non-Androgynous	ISS (USOS), MPLMs, HTV, Dragon Cargo, Cygnus	Enormous compatability, largest diameter.	Offers only Berthing conection.
International Berthing and Docking Mechanism	Docking or Berthing	800 mm	Androgynous	(IDA) on the US side of the ISS, Dream Chaser, future ESA support	Enormous compatability with future ESA support for future spacecraft compatability. Offers Docking or Berthing connections.	
NASA Docking System	Docking or Berthing	800 mm	Androgynous	future US support. International Docking System Standard compliant	Enormous compatability with future US support for future spacecraft compatability. Offers Docking or Berthing connections.	Does not offer as much livable space. Worse radiation protection.
Chinese Docking Mechanism	Docking	800 mm	Androgynous	Shenzhou spacecraft, other future Chinese cargo resupply vehicles.		Contradicting reports on its compatability with APAS-89/95. Limited to Chinese spacecraft.

The Common Berthing Mechanism (CBM) was chosen because it allows a wider channel of circulation between modules as well as its ability to allow large objects to be unloaded from compatible resupply spacecraft. The CBM also provides a means to connect each module to air, water, and electrical piping inside the airlock body, instead of running a pipe inside the opening. The International port was implemented only on the spaceport module to allow a greater range of incoming spacecraft to dock with Phari. Because it has a narrower diameter, it was not placed elsewhere on the station.

### 7.2 Connectors

Please go to 8.2 ‘Torus Configuration’ to read about the ECLSS subsystems that support the Phari base.

### 7.3 Modules

The modules that compose the Phari base are broken down into five sections; the Command Module, Crew Quarters, Support Module, Power Module, and Spaceport / Centrifuge module. For how these modules were composed, Figure X below shows the characteristics between traditional metal modules and the more recent inflatables.

Module Variants	Composition	Weight	Deployed Volume	Ballistic Protection	Radiation Protection	Key Advantages	Key Disadvantages
Inflatable B330	Kevlar and Mylar	21.5 Tonnes	330m <sup>3</sup>	Superior	Superior	Greater volume of living space for a given mass. Provides ballistic/radiation protection superior to traditional aluminum shell designs.	Cannot construct walls or hard plumbing prior to launch. Must be 'filled in' after deployment.
Inflatable BA2100	Kevlar and Mylar	65-100 Tonnes	2100m <sup>3</sup>	Superior	Superior	Greater volume of living space for a given mass. Provides ballistic/radiation protection superior to traditional aluminum shell designs.	Cannot construct walls or hard plumbing prior to launch. Must be 'filled in' after deployment.
Metallic Body	Aluminum (Weldalite 049-T8)	15-90 Tonnes	Varies	Good	OK	Can be hard wired and built prior to launch, so it arrives as it needs to be.	Does not offer as much livable space. Worse radiation protection.

While the inflatables offer a large amount of volume, creating distinct spaces, in particular, hygiene and scientific, would be rather difficult to incorporate in a modular setting. The special programming for the modules was so specific that a metallic design was decided. The radiation protection from Stickney Crater would compensate for lower protection rates in metallic module designs.

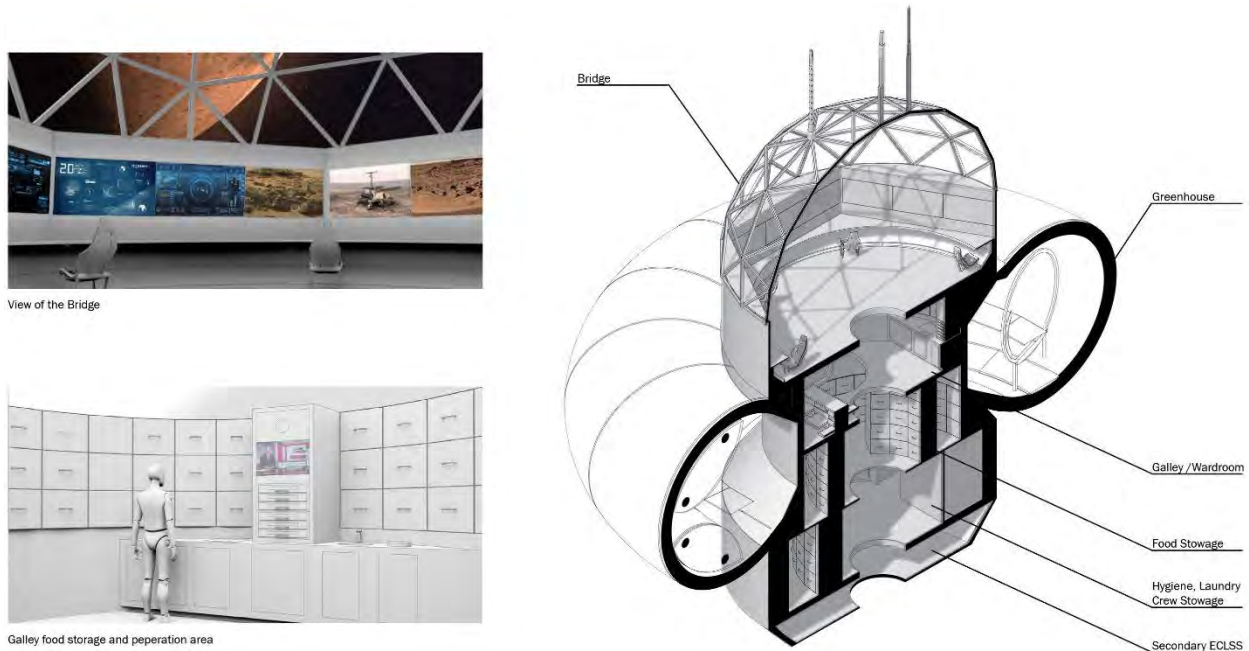

Figure 7: CM & Galley Renderings

The Command Module would house the systems monitoring for ECLSS, RECLSS, power consumption/generation, spaceflight and EVA support, a Mars direct observatory including VR for robotic ground support, and a direct astronomical observatory. Below that would be the Greenhouse, a galley/wardroom for up to twelve people at once, food storage bins, laundry, hygiene, and two restrooms.

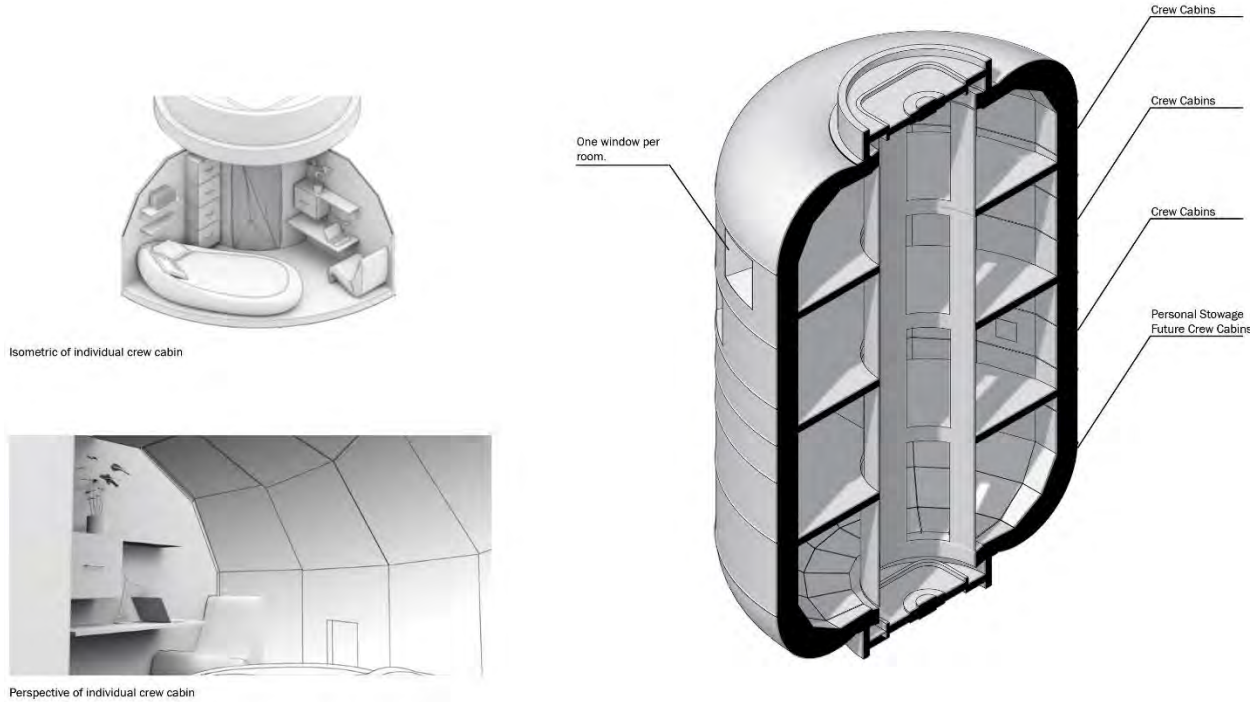

Figure 8: Crew Hab Renderings

The next module down would be Crew Quarters, which is outfitted in a Bigelow B330 inflatable. With a total of four floors, the first three would be dedicated to twelve equally spaced crew compartments with the last floor being person crew stowage. Crew members would enter through a sound-absorbing mesh doorway that would retract after they pass through it. Inside, almost all the furniture would be inflatable or small enough to bring in from other parts of the base (such as the, shelves, desk top, and wall storage bin). Using a simple bracket mounting or Velcro strap system, each room could be configured to the personnel's desired layout.





Medical bay with surgical robot



External transfer floor with CBM airlock hatches

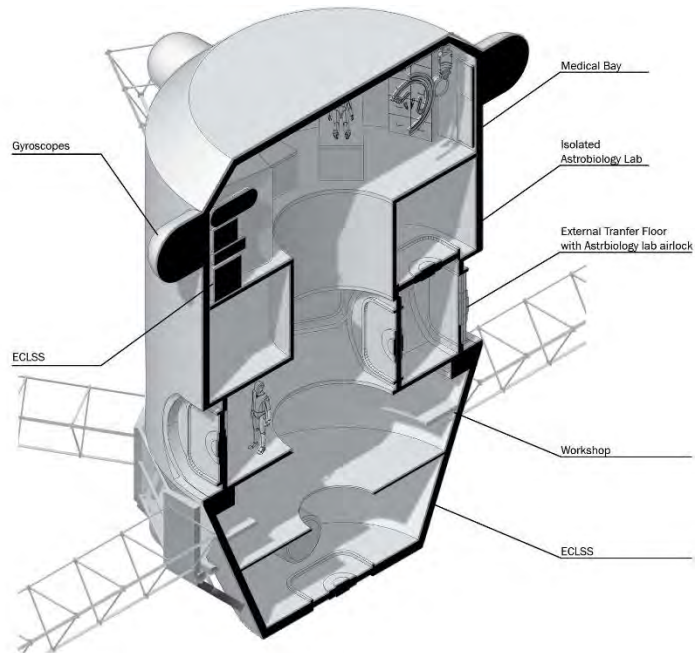

Figure 9: Medical Bay, Airlock Bay & SM Renderings

The Support Module would house the medical, and ECLSS on one floor. The medical bay includes three wall-mounted beds that can fold up and a ceiling-mounted surgical arm that can perform on injured crew members. Below that is a transfer node floor with six airlocks. Five of these airlocks will lead to future expansions of the base. Only one is used at the initiation of Phari, this takes crew members to the Spaceport and Centrifuge. Below this transfer floor houses the workshop, an area dedicated to 3D printing special parts critical to the upkeep of the whole base.



Figure 10: Power Module Renderings

Below the Support module is the Power Module, which houses the nuclear reactor of Phari, a power control room, a battery bay, and a chamber for a stator and rotor.

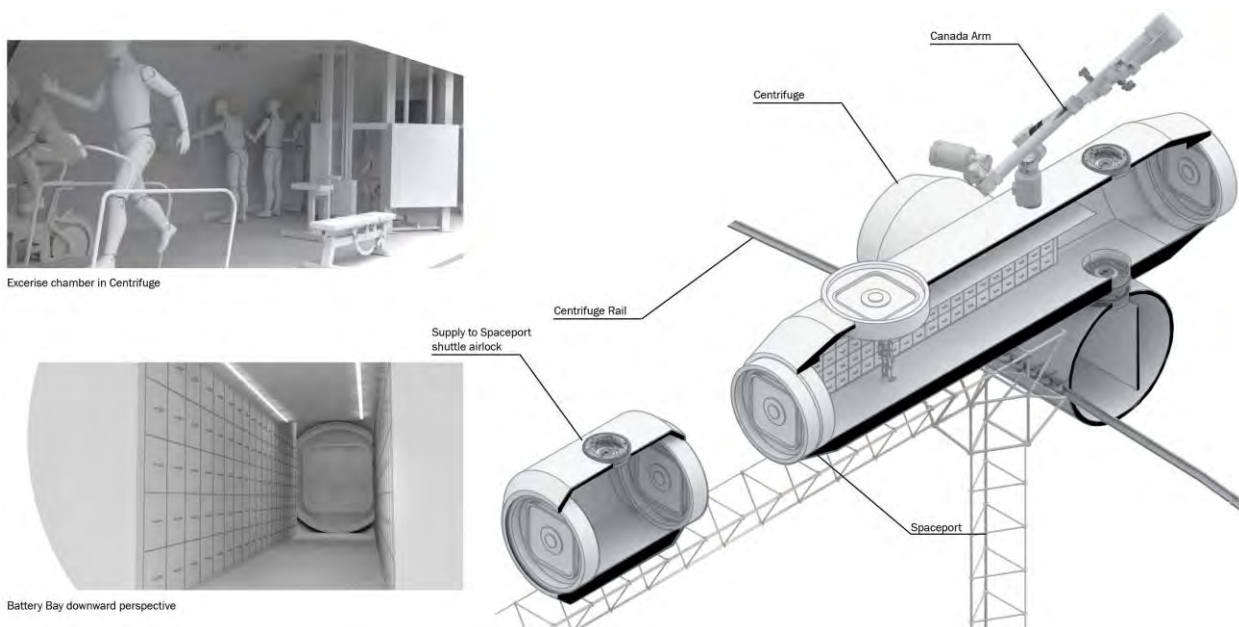
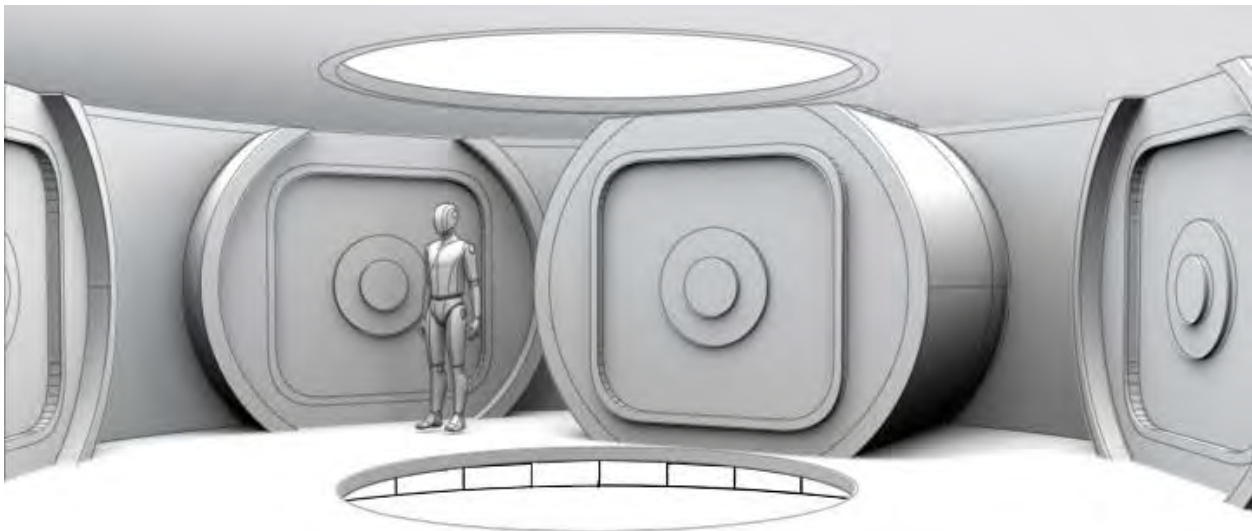

Figure 11: Spaceport & Artificial Gravity Module Renderings

The Centrifuge and Spaceport are only accessible through a pressurized airlock shuttle that would travel along the truss system anchoring the base to the ground. The Spaceport is composed of a long hallway that has storage capability to quickly unload stowage from resupply vehicles. This space contains a Common Berthing Mechanism and an International Berthing and Docking Mechanism to accommodate various current and future spacecraft to the Phari Base. The end of the spaceport contains a hatch that leads to the centrifuge module, which can emulate various gravity gradients. This module would be critical for increasing the effectiveness of exercise and overall crew health on station and before and crew may descend onto the Martian surface.

## 7.4 Nodes

Because the Phari base took on a vertical orientation, nodes were only used in two cases; as a means of future expansion and to provide various means of entry for the space port. The lower part of the support hab features a floor that has 6 CBM airlocks, 5 of which can be used to connect to other shuttles for future base expansion (Shown below in figure 12). This area would serve as the most busy circulation hub for the base.



*Figure 12: Airlock Bay*

## 7.5 Structures & Utility Routing

The truss design is a key element in anchoring the Phari base to Phobos. A series of trade studies was conducted for both its physical shape and its material characteristics. Our goal was to create a truss design that could provide the longest distance, the shortest foldable dimension, ease of assembly, the lowest amount of weight, and the highest robustness.

### Truss Material Trade Study

Material selection for truss manufacturing is a critical design aspect that influences overall launch manifest and reliability of the base structure including physical shape of the truss and its capabilities. Four materials were examined:

Proposed Material Characteristics	Content	Tensile Strength	Density	Melting Point	Young's Modulus	Key Advantages	Key Disadvantages
Aluminum (Weldalite 049-T8)	Aluminium, Lithium	710 MPa	2.66 g/cm <sup>3</sup>	600-655°C	69 GPa	Proven for space applications, has been selected as metal of choice of Orion capsules. Corrosive resistant.	Does not take blunt forces well. Medium weight
Magnesium Alloy (Elektron 21)	Neodymium, Gadolinium, Zirconium, Magnesium, Zinc	275 MPa	1.8 g/cm <sup>3</sup>	545-640°C	45 GPa	Very lightweight, non-Corrosive, high chemical resistance.	Can easily be bent. Thermal expansion during manufacturing can cause irregularities.
Carbon Fiber (IM10)	Typically 95% carbon, 5% resin	3310 MPa	1.79 g/cm <sup>3</sup>	3652 °C Resin: 260 °C	30 GPa	Does not fatigue, high stiffness, high tensile strength, low weight, high chemical resistance, high temperature tolerance and low thermal expansion, non poisonous, biologically inert and is a shape-memory polymer, non-corrosive.	At temperatures above 66 °C, carbon fiber resin strength will be reduced. Cannot easily handle isotropic force, strength focused on direction of fiber.
Maraging Steel (Grade 350)	Nickel, Cobalt, Titanium, Molybdenum	2,400 MPa	8.1 g/cm <sup>3</sup>	1,413 °C	210 GPa	Extremely strong and high temperature threshold, very rigid.	Is not flexible, will snap instead of bend, heavy. Least corrosive resistant of all options.
<b>Unit Legend</b>							
Mpa: Megapascals   GPa: Gigapascals   mm: Millimeters   cm:Centimeters   g:Grams   °C: Celcius							

The first option considered Aluminum (Weldalite 049-T8), which is currently used on the ISS and the upcoming Orion spacecraft. It is known for its anti-corrosive properties and is perhaps the strongest commercially available aluminum. However, Weldalite 049-T8 does not take blunt forces well if its thickness is under 4 cm. Therefore, every limb and connection of the truss will have to meet this requirement making the Phari's truss configuration comparatively massive.

The second material considered was a Magnesium Alloy (Elektron 21), which is a mix of Neodymium, Gadolinium, Zirconium, Magnesium, and Zinc. While its tensile strength is lower than aluminum, its density at 1.8 g/cm<sup>3</sup> is incredibly low for a metal while still retaining the same melting point and only a smaller Young's

Modulus at 45 GPa. It does have the same bending issues with blunt force related with Weldalite 049-T8, and because of the many metals in the alloy, it has greater thermal expansion issues after being manufactured than most common metals. Having this lack of uniformity in metal strength or size could present serious problems for Phari's truss, which has to be capable of extending up to 100 meters in every direction.

Carbon Fiber (IM10) was the third option and the first non-metallic material as a truss material. At 3310 MPa, IM10 is a relatively new generation of carbon fiber that has incredibly strong tensile strength. It does not fatigue and possesses high stiffness, high tensile strength, low weight, high chemical resistance, high temperature tolerance, low thermal expansion, non-poisonous and biologically inert, non-corrosive, and, most interestingly, is a shape-memory polymer. However, carbon fiber is a weave of carbon strands that is held together with a resin that is much weaker than the carbon fiber itself. Additionally, perhaps the greatest weakness of carbon fiber is that it cannot handle forces isometrically (forces from all directions). It can handle forces in one direction only and in case it is made to handle isometric forces, the carbon fiber becomes thicker, denser, and heavier, all at a cost of strength.

The final material examined was Maraging Steel (Grade 350). This is one of the strongest types of steel available and is an alloy of Nickel, Cobalt, Titanium, Molybdenum. Though not as strong as carbon fiber, it is extremely strong and possesses a high temperature threshold. The rigidity and the weight of the material can be detractors. Due to its rigidity, it will not give any clues to its failing and will instead just snap when the metal fails. This makes the health of the metal very hard to monitor and would require a strict timeline of when it should be replaced. The metal is the most corrosive of the four considered and presents potentials for unforeseen challenges related to unknown factors in the composition of soil.

### **Truss Design Trade Study**

A total of three designs were considered that all possessed an ability to fold and extend either with mechanical or robotic aids (Figure 13).

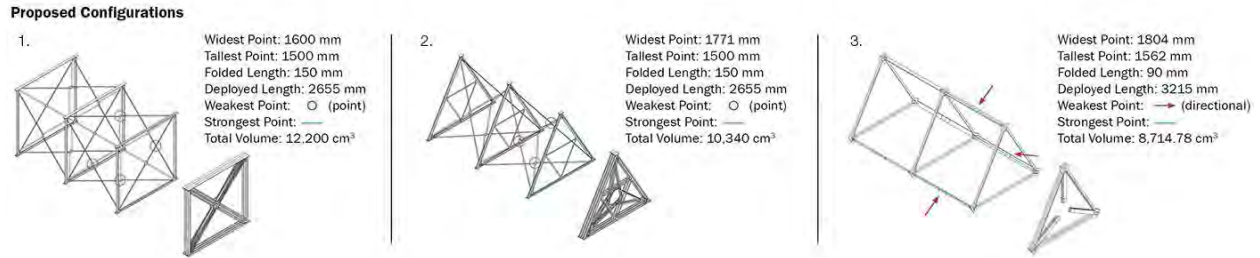

Figure 13: Truss Configurations

Truss 1 (shown as ‘1’ in figure 13) is the first iteration that relies on a pressurized bolt that would lock the frame once it reached its fully deployed position. A square shape provides support for any structure above or below the truss. However, the square truss is folding in the direction where primary load forces applied, and where the truss needs major reinforcement (between the Phari Hab modules and Phobos’ bedrock).

To attend this issue, an alternative option - Truss 2 (shown as ‘2’ in figure 13) is developed and investigated. Truss 2 offers mass reduction due to its triangular shape while still relying on the same pressurized bolt to fix the truss in a deployed position. While the bolt’s inability to ‘unlock’ may not be a hindrance, bolt connections are still considered to be points of weakness when under immense compression force – the maximum stress these trusses would experience.

Truss 3 option (shown as ‘3’ in figure 13) is a design that steps away from a pressurized bolt assembly and instead relies on Heat Panels that are made of Minco Polyimide Thermofoil. These panels can work in (-200)°C to 200°C temperature ranges and have already been used by NASA in zero gravity conditions. Such properties defined by shape-memory polymer characteristic of the material. The small panels require 17.49 watts per 1 unit (as drawn in ‘3’) to heat to 130°C, the necessary temperature to cause the carbon fiber to revert to its original position and secure the truss in its deployed position. It takes 15 minutes for each section to be deployed.

### Chosen Truss Design

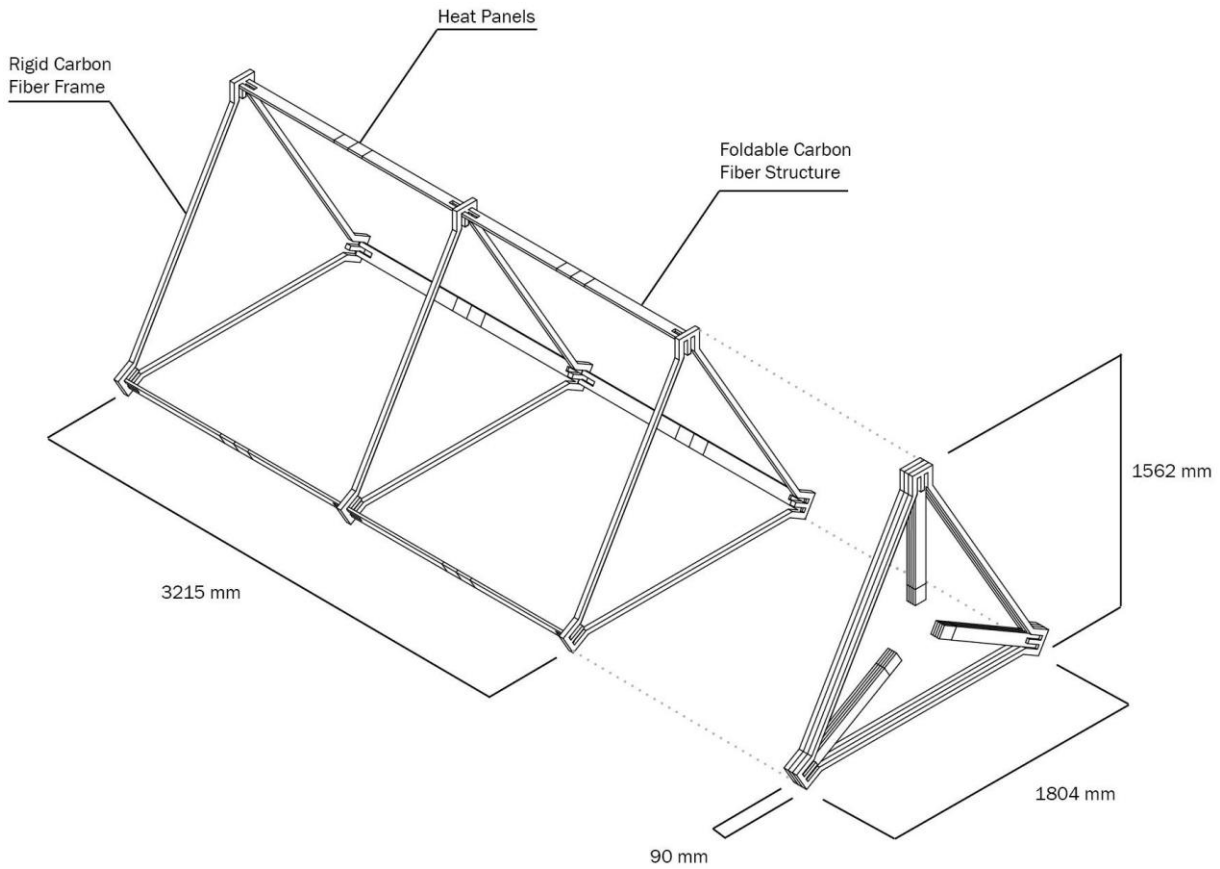

Figure 14: Chosen Truss Design

The chosen truss design, shown in Figure 14, has a volume of 8,714.78 cm<sup>3</sup>. To attain the necessary length of 90 meters, it only requires 2.52 meters (28 units) in a folded position for launch. The total weight of each segment (as drawn) is 15.60 kg in 1 g and 436.8 kg per 2.52 folded segment in 1 g. This low weight would be due to its carbon fiber material makeup.

## 8.0 Designs & Estimates

### 8.1 Subsystem design and selection

#### Atmopshere

The subsystems of the Phari base are based on the ones used on the ISS today, fans, conducts will be outfitted on the inside walls of each module. [10] Ducts, filters are based on today's standards.

#### Lighting

The Phari base will use the LED technology for its power efficiency and for its capacity to generate specific spectrums of visible light. To mitigate effects of circadian rhythm dysfunction due to the 8 hour day/night period on Phobos, lighting will use a 24 hour pattern to accommodate human needs.

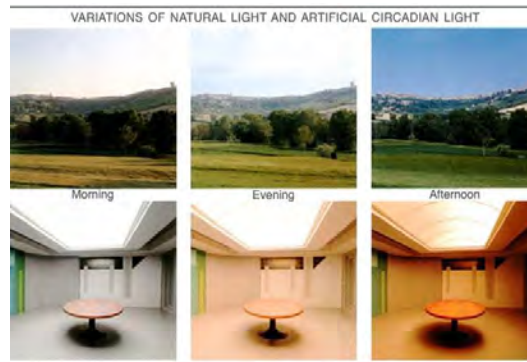

Figure 15: Examples of Lighting

### 8.2 RECLSS engineering schematics

The goal of this system is to provide for 50% of the food of a crew of 12 for a period of 24 months maximum. Our system is therefore designed according to NASA requirements. Those requirements include 30 square meters of crops for a mainly vegan diet.

In case the RECLSS system fails, at least 60 tons of food needs (considering a standard food product to contain 4 kcal per gram) to be packed in the base just to insure the survival of 12 people for 24 months.

Other animals products will be provided by storage and resupply missions.

- Solutions for such a system include but are not limited to:
- Horizontal plantations using solid ground



- Vertical plantations with gravity induced water distribution
- Aquaponics system (Too many variables and studies on the behavior of fishes in space is not complete enough)
- Hydroponics system (Only usable in partial or full gravity, simple process and no requirement for a pump)
- Aeroponics (Requires many mechanical elements and tubes, could increase water dispersion)
- Biosolids production using compost with worms
- Biosolids production using compost with anaerobic digestion and extreme heat

The best possible choice to insure a continuous and healthy diet of vegetables is through the technology of the rotating garden, it will combine the principle of aquaponics with the design of Omega Garden™.

Auxins is a term that is not widely known by the public. Auxin is a plant hormone that causes the elongation of cells in shoots and is involved in regulating plant growth. It is most important in a plant life as it tells the plant in which direction to grow and how. Experiments on current and past space stations (being in micro-gravity) have shown that the lack of gravity impacts negatively the plants and do not promote plant growth [fig 1].<sup>[11]</sup>

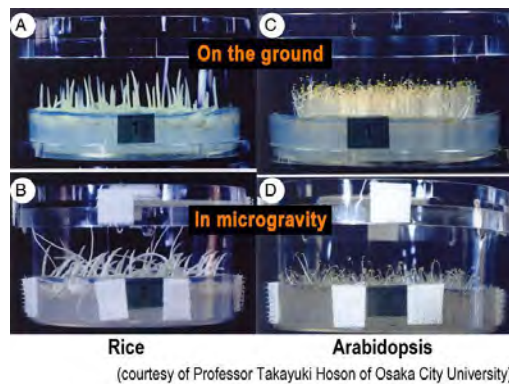

Figure 16: Effects of zero gravity on plants

Therefore, gravity needs to be recreated onboard the ship while traveling to a celestial body or a desired location in space.

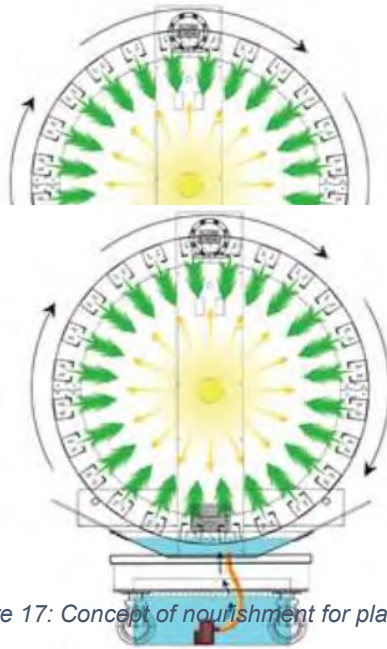

Figure 17: Concept of nourishment for plants

When gravity is present, this system will still work as a catalyst to augment the production of auxins and increasing the yield.

Based on studies made by Omega Garden Inc, that system can achieve 3 to 5 times more yield than conventional hydroponics. [3]

The plants will rotate around a central axis at a speed of 1 revolution every 45 min in an environment of 1 g. The rate of rotation will increase as the gravitational pull decrease, for example in a 1/2 g environment a full rotation will take 22 minutes. The radius of one the rotating garden is 1.42 Meters, this distance is calculated based on the median height of the plants that will be grown inside. The full structure diameter is 3 Meters.

### Light distribution

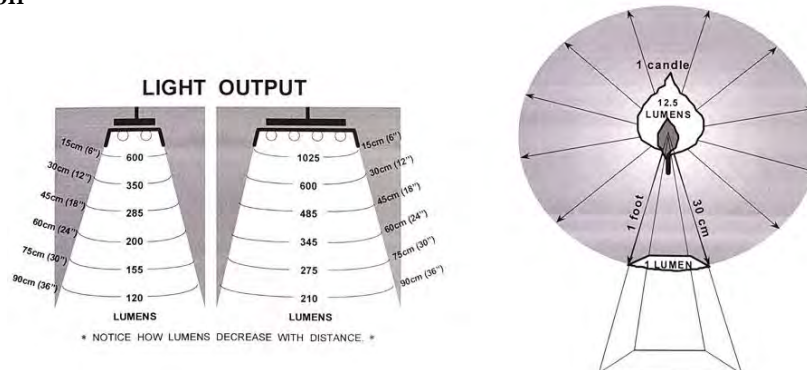

*Figure 18: Light analysis*

The light distribution is not extremely efficient in a classic hydroponic garden. Most of the photons are lost due to the plan repartition of plants and most of the plants are not ideally located around the light source.

The rotating garden alleviates those problems by placing the light source directly in the middle of the system, therefore making each plant at an equal distance from the light source without losing any photons [fig 3].

For the lighting device itself, the technology used will be LED's, that prove to be far more energy efficient and have a longer lifespan than traditional incandescent light bulbs.

Research has also proven that plants do not require the full spectrum of colors contained in ordinary daylight to grow. Philips inc and experts have created a tailor-made color palette of red and blue light that is required to enhance the whole process of food production. [10]

## **Water distribution**

### *Gravitational forces applied*

The root of the plants, encompassed in their growing medium made first of rockwool and then compacted compost will go through a water tank, the slow rotation of those roots and growing medium will be able to retain the exact amount of water and nutrient necessary for their accelerated growth. The pull of gravity on the water should be enough to counteract the capillarity force inherent to water, if that force is not strong enough, the environment should be considered in lack of gravity.



Fig 18A - Example of omega gardens

*Lack of gravity*

When in a micro-gravity environment, water distribution becomes a problem since water tends to stick to the roots of the plant and suffocate it, this rotating system already takes care of that problem by providing centrifugal force and therefore getting rid of excess water. The system used in that environment will be Aeroponics, it will consist of a water distribution system that produces mist directed at the rotating growing medium.

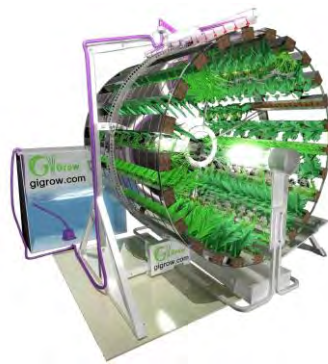

Fig 18B – Example of a rotating garden with aeroponics

**3. Torus configuration**

The torus configuration is ideal for the needs of the rotating garden. It provides a circular interior space suited to house the cylindrical shape of production units.

The inflated volume allows for at least 5 units and a central pathway to harvest and plant the vegetables. The rotation of the units on a single round structure allows to minimize the number of moving parts and use a single water tank at the bottom with gravitational forces applied. In the case of a lack of gravity the mist could be ejected from anywhere as long as the action of the pumps are coordinated with the rotation cycle of the full structure

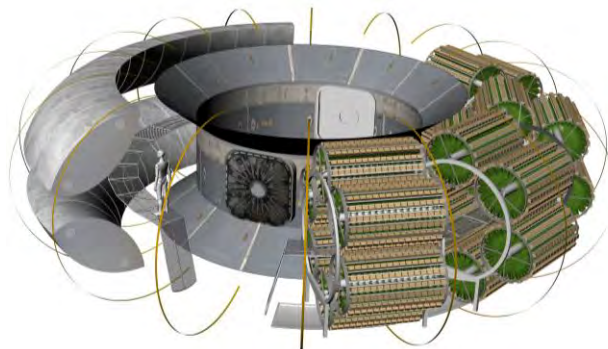

Fig 18C – Architecture of the greenhouse.

The retrieval of the CO<sub>2</sub> by the crew will involve a full circulation of the gases contained in the habitat through the greenhouse in order to provide for the needs of the plant. If a crew member expels 1 kilogram of CO<sub>2</sub> per day, then a crew of 12 will expel 12 kg per day. [12]

It was tested on the BIOS 3 experiment by Russia that only 13 square meters of growing area was needed for a single human to have all their oxygen needs satisfied. [13] Extrapolating from this research we can safely say that 156 square meters will be sufficient to transform the CO<sub>2</sub> into O<sub>2</sub>. To the needs of the humans we also need to add the requirements of the worms, they will require less oxygen than the 12 people crew but we can estimate their needs to be 60% of the crew of 12 (7.2 kg per day).

Since the greenhouse provides 210 square meters of growing plants. All the organic needs will be satisfied. The ECLSS system shouldn't need to be activated at any time for Atmosphere recycling.

Redundant ECLSS systems will still be present throughout the station but the only places that will need an active ECLSS system just as the one installed on the ISS are:

- The shuttle module
- The spaceport
- The centrifuge modules<sup>[14]</sup>

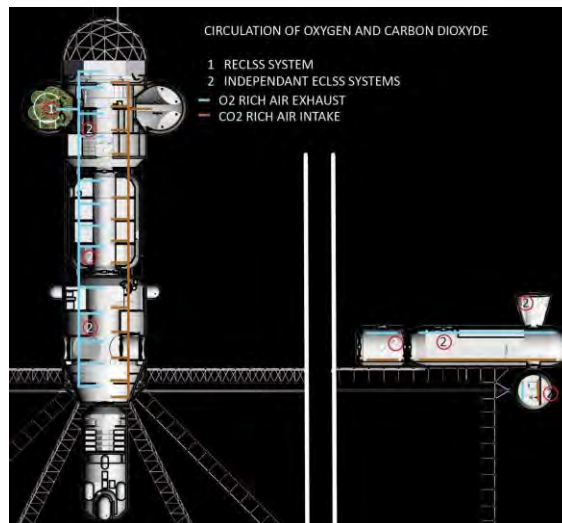

*Figure 19: Phari Base circulation diagram*

Equipment for the life science :

- Collapsible structure that will hold the growing medium
- Growing medium:
  - Rockwool
  - Compost
- Inflatable pockets for compost processing
- Motors and structure to rotate the plantations
- Collapsible passageway for collection and inspection
- Pumps/Fans for water and air circulation
- Pump/mixer for the water/urine treatment
- Tools to harvest and maintain the plants

### *8.2.1 Greenhouse assembly and construction*

#### **Transfer of the equipment**

All of the equipment that will be necessary to accommodate plant growth will be housed inside of the solid part of the torus module and will be transferred through two common berthing mechanisms that are located in the center and opposite to each other. The crew through the hatch will bring, pumps, sensors, cameras, electric wiring, data wiring, compost bags, collapsible standing structure, collapsible water tank, mist dispensers, rotating gardens [fig 11], harvesting tools and of course the seeds.

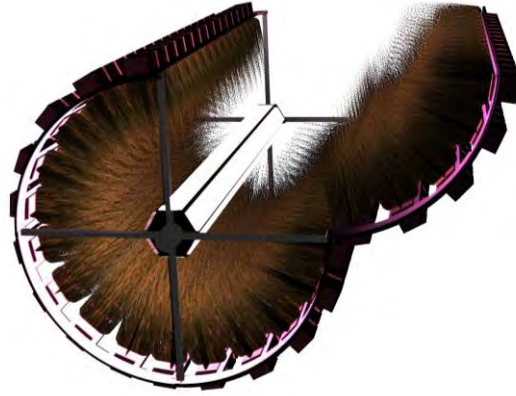

*Figure 20: Rotating Garden*

## **Installation**

Most of the equipment will have to be collapsible since space is limited, this can be achieved by segmenting any necessary structure and reducing the mass of the material used. The crew will have to go through the center of the module and start to move the components that are located in front of the hatches. Once that is done, the opening will allow for all the components to be fitted inside the inflatable space just as shown in figure 18. A removable secondary structure will be installed [fig 18] around the elements that need solid connection, rotating gardens, pathways, compost bags.

## **Connection to power, air ventilation, water circulation and transport of biomass**

The circulation of air, water, electricity and data will be operated through the common berthing mechanism vestibule, connections are already present and have been designed for an optimal air flow along the walls of the module. Pumps will provide necessary circulation for the water from the humidity condenser located in the habitat and greenhouse, urine will be circulated using a separate system that will feed directly into a tank designed specifically to arrange 1 quantity of urine for 8 quantities of water.

Air will be circulated with fans from any part of the habitat to the green house via two different circuits, extraction and distribution, polluted air will be extracted through one side of the greenhouse and circulated again back in the habitat through another set of fans back to the habitat.

Regarding air circulation for the compost, this will be a special circuit since the smell must be filtered, the intake will come from the bottom side in the figure 21 and will expel filtered air to the top part in the figure 21 to feed and augment the flow of CO<sub>2</sub> air to the plants.

### *8.2.2 Greenhouse operation*

#### **Transport of organic material for compost**

Transportation of human feces and food waste will be accomplished with a semi-rigid collapsible bag, those bags will be made of opaque material since worms prefer a dark environment and the view of the compost with its inhabitants can be unsettling for humans.

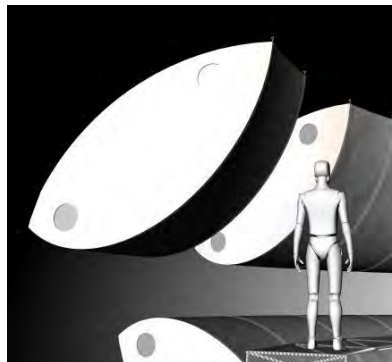

*Figure 21: Collapsible Compost Bags*

They will be attached to toilets of the habitat to collect human feces and will be detached when half-filled. The two openings on the bags shown on the figure 12 will be used to fill the bags with organic matter and air circulation. When the cycle is complete, bags will be closed to prevent air contamination and retain the organic compound inside. When properly connected to other bags, the openings will be operated again to allow worms to travel between bags without human intervention, the other opening being used for air circulation again, allowing enough oxygen for the worms. Two fans at each end of this circuit will take care of circulating air with special filters to prevent smell from getting out.



### **Compost and nutrients mix**

The cultivated area at full utilization will be 210 square meters, enough to satisfy crew's calories need. Nutrients will come prepacked to be added to the water.

Those nutrients will be Boron, Manganese, Sulfur, Copper, Iron, Zinc. Nitrogen will be provided by the water/urine mix, worm compost will provide for Phosphorous, Potassium, Calcium and Magnesium. All those nutrients will be present in the final stage of the compost and will be packed into a cube format to receive the seed of the future plant, this cube will be housed in a semi porous container to be carried through the nutrient rich water in the rotating garden. A special pump and mixer will be used to mix the water/urine with the nutrients that can't be produced by the worms.

### **Rotation of the plants and harvesting**

The gravitational pull on the plants will naturally produce auxins in them, making them more efficient at photosynthesis and nutrient absorption, the principle of the rotating garden as explained and designed by Edward Marchildon just improves on that natural reaction by forcing the plant to readjust its growing pattern at every rotation, auxins will be better distributed and plant growth will be increased. Harvesting will be done on the pathway, rotation will stop for the time necessary to harvest or plant new vegetables. One entire unit can be circulated through the structure and be repaired and or changed.

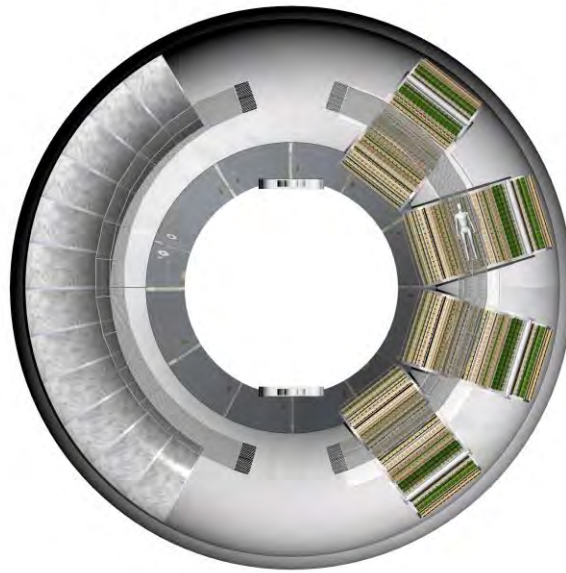

*Figure 22: Arrangement of Greenhouse equipment*

### **Human needs**

Humans need at least 2,800 calories per day, this estimate is based on a paper by the US department of agriculture.<sup>[14]</sup> They also need 2 liters of water, based on a study by the food and nutrition board.<sup>[15]</sup> Regarding oxygen, a human being uses about 550 liters of pure oxygen (19 cubic feet) per day.<sup>[16]</sup> Using those numbers, we can start sizing greenhouse to accommodate a certain number of humans for a certain period of time. The crew will need 73 g. of protein and 32 g. of fat per person per day over the course of two years. 2800 kcal/person/day so for a two year mission with 12 crews they would need  $2800 \text{ kcal} \times 12 \times 730 = 24528000 \text{ kcal}$  total.

### **Plant needs**

The goal is to produce a complete diet and to recycle all waste products including human waste from the crew while maintaining an atmospheric balance suitable for plant growth and human habitation. In general, temperatures will range from 15.5 to 32.2 deg. C. with humidity ranges between 30% and 45%. Materials will be selected with no toxic out-gassing

## **The envelope**

The conditions outside of the biosphere are harsh and dangerous for any kind of carbon-based life. Pressure is expected to be very low, temperature will range from just a couple of Kelvins to 425 Kelvins. Radiation will also be a problem but mitigation strategies are not in the scope of this paper. The envelope of the greenhouse has to be able to accommodate multiple conditions, it is expected to be deployed in orbit around earth to feed the crew while traveling and to be able to be resettled on celestial body (Mars, Moon...). Since the inflatable volume cannot house any of the equipment that will be installed in the future, most of it will be housed in the central volume of the torus configuration. Other configurations will handle that storage situation differently.

## **Compost**

Composting will be necessary to process and recycle all organic waste generated by the crew and harvesting plants. Human waste (feces) will be collected in a semi rigid structure with an inflatable core that will contain human feces, worms (*Eisenia fetida* or red wigglers ), plant and food left-overs. With enough humidity and air, the worms will breakdown those components into usable compost containing multiple nutrients, the only residues of the process will be heat and CO<sub>2</sub>.

## **8.3 Mass flow estimates**

The total volume of gases that the habitat will contain (in addition to the air tanks) will be of 1,800 cubic meters for a cabin temperature nominal range of 65 to 80°F (18.3 to 26.7°C), a pressure nominal range of 14.2 to 14.9 psi and an air velocity of 10 to 40 feet per minute. Those numbers are based on settings that are used on the ISS. <sup>[16]</sup>

## 8.4 Resupply estimates

If no food were to be produced on the station, that would imply a tonnage of 61,32 (considering a standard food product to contain 4 kcal per gram) for a crew of 12 for 24 months. Studies have showed that food represents a very important part of a crew member's morale. Vegetables will not be able to provide the crew with a varied and complete selection of produce to satisfy their gustative needs.

Resupplies will use a standard commercial vehicle that will be developed by now, either using Space X or Blue Origin (refer to 4.7 for trajectories). Those vehicles will hold water, food (15 tons of food every 12 month and 1/2 ton of water) and new experiments. Tools and equipment as required by the research to process and harvest Phobos natural resources. Spare parts and material will be shipped to the base in case the stock of already stored spare parts and material is used and if the 3d printing of new parts is impossible using the resources on Phobos.

## 8.5 ISRU estimates

Based on a research done by Brown University, Phobos is expected to contain 13% of water.<sup>[15]</sup> Multiple small satellites are expected to be launched to study the composition of the primary layers of Phobos surface. Those satellites will be launched two years prior to the arrival of the crew to assess the tools required to harvest the available material. After the assessment of the situation is complete. It is expected that the crew will conduct experiments on Phobos surface to collect and process samples of dust and rocks.

The workshop and astrobiology lab will be used to estimate the needs and processes that will be used in the future expansion of the base, the Facility module that will be located on one of the vertical trusses around the perimeter (fig 8). Fuel production will be done using electrolysis.<sup>[17]</sup>

Fuel depots will be located on the outer ring for safety reasons. They will be surrounded by a thermal blanket [fig 8], this thermal protection will also act as a shield against impacts on the fuel depot and the potential explosion of the fuel tank itself. Fuel transfer will be done using pipes that will be thermally isolated to keep the Oxygen and Hydrogen liquid.

The spaceport will be directly connected to the fuel depots and the main habitat in phase 1, in phase 2, lines between the main habitat will be cut and reconnected to the future facility module.

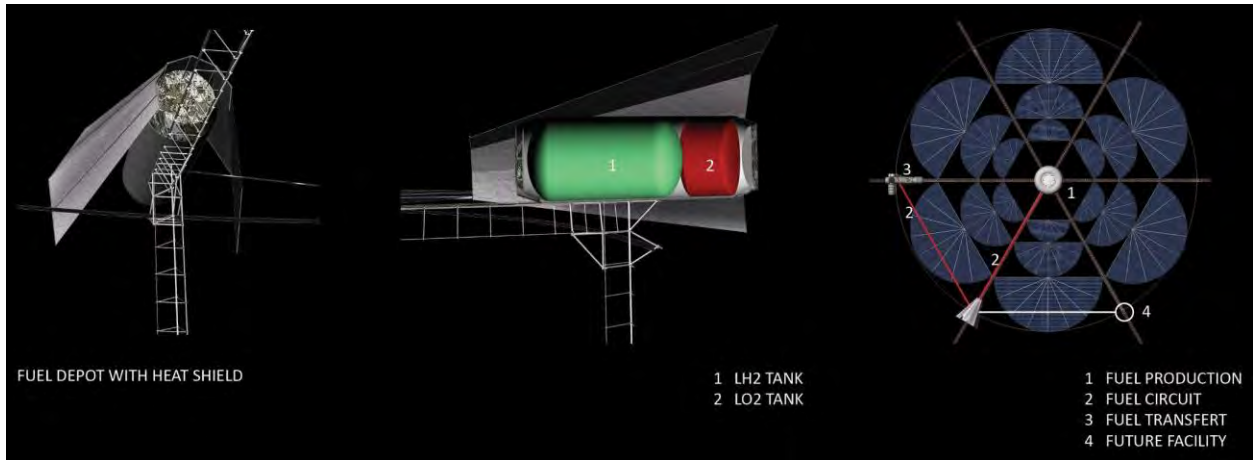

Figure 23: Fuel Depot

## 9.0 Life Science Countermeasures

### 9.1 Microgravity

As is well known, Long-Duration Exploration Missions (LDEM's) pose several health risks to crew members, particularly with the duration of exposure to a weightless environment. With zero G's loading their bodies throughout normal movement and activity, crewmembers on LDEM's are susceptible to bone demineralization, muscular atrophy, cardiovascular deconditioning, and many other physiological effects. Under these circumstances, crew performance will be negatively impacted, if not completely hindered, upon reintroduction to a gravity environment. This can inflict disastrous consequences on the success of a Mars mission considering a crew, with now severely deconditioned bodies, being pulled into a 0.378 g planet and being expected to conduct landing checks and procedures once on the surface.

Traditionally, exercise machines have been used as countermeasures to mitigate health risks presented by the weightless environment. However, it has been well documented that such equipment provide limited benefits, and would be considered inadequate on long-duration missions to Mars or to other deep-space destinations.<sup>[18]</sup> Thus alternatives, such as the argument for creating artificial gravity (AG) via centrifugation, become attractive.

Advocates for rotating habitats have proposed several designs over the years, all of which take into consideration the four main factors at play in a rotating structure: radius length, angular velocity (rotation rate), tangential velocity (rim speed), and centripetal acceleration (gravity level). Considering their interdependent nature (see Figure 1), these factors result in trades tied to crew safety and cost. For example, in designing a centrifuge, if one were to choose a slower angular velocity so as to prevent injury of crew and to mitigate motion sickness, a longer radius would be needed in order for the structure to produce the commonly desired 1 g. However, a larger radius would imply a more expensive structure. Thus, in the spirit of minimizing costs, one would have to work with a shorter radius, which in turn, suggests a faster angular velocity, which, depending on where the balance is set, May still pose harm to crewmembers.

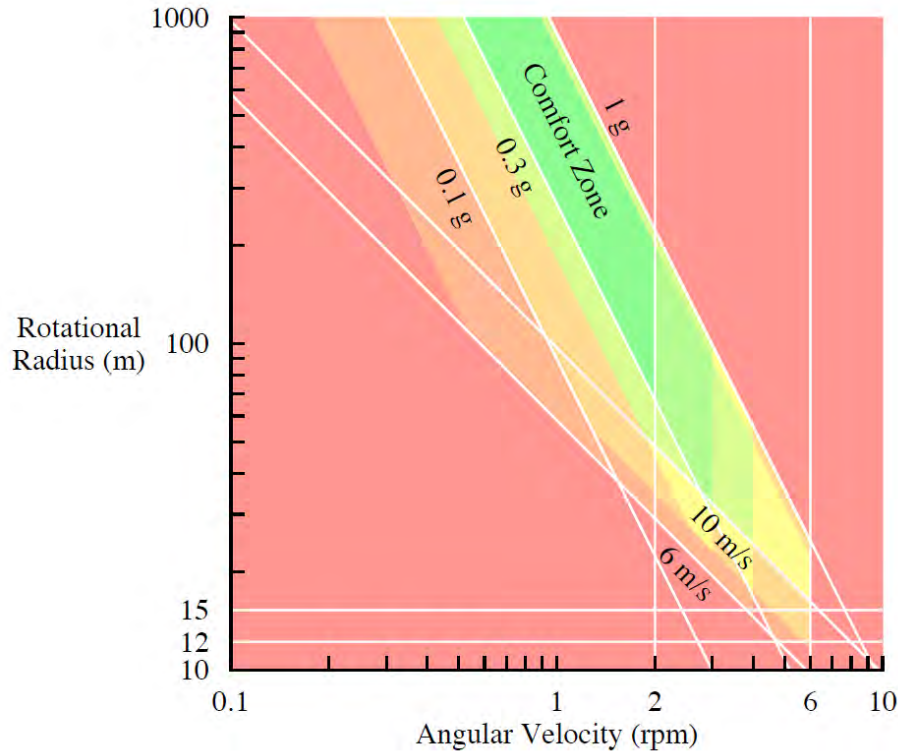

Figure 24: Comfort chart for a rotational AG environment depicting the relationships between radius, angular velocity, and corresponding g-level. Areas of green are likely areas of comfort; areas of yellow or orange may be areas of comfort or discomfort, and areas of red are areas of discomfort.<sup>[19]</sup>area

If this were not enough, AG is more involved than simply manipulating radius length and angular velocity to produce one uniform gravity level. No matter the length of the radius, or the angular velocity, a gravity gradient is always present. This gradient increases in range the shorter the radius, and approaches a value of zero the longer the radius (Figure 2). For example, with short-arm centrifuges, it is possible to simultaneously create 0 g at the head and 1 g at the feet; whereas with long-radius centrifuges the difference in gravity felt at the head with that at the feet can be so miniscule that it is actually negligible. Though some research suggests that a full gravity gradient is tolerable and can still be beneficial to health in particular ways, it will nevertheless pose complications for any kind of physical activity or movement in an AG environment.<sup>[20] [19]</sup>

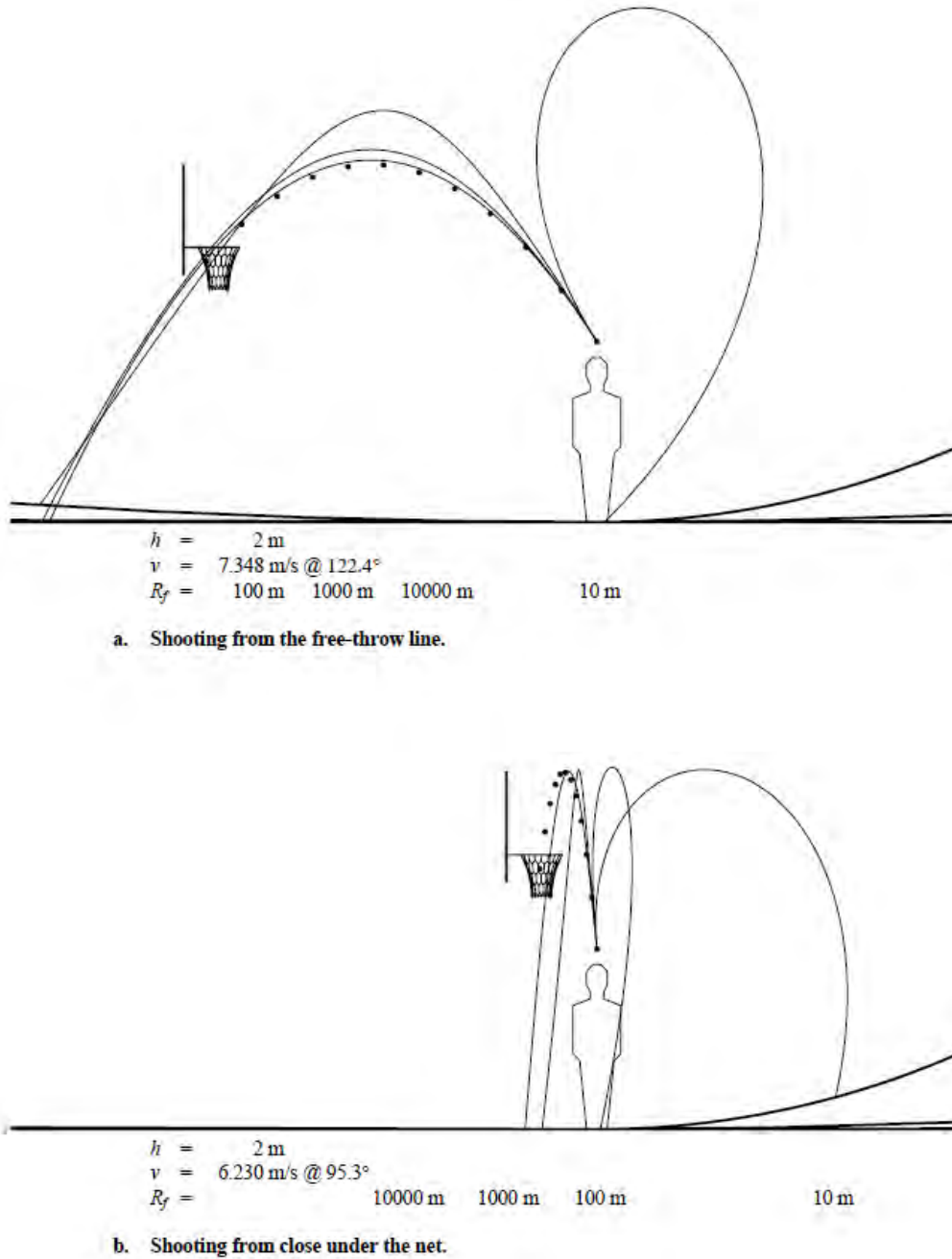

Figure 25: Shooting a basketball in AG gradients of different radius lengths. A successful shot on Earth is shown dotted for reference.<sup>[19]referenc</sup>

Research has shown that the success and the extent of benefits of a rotating habitat also depend on crewmembers' activity level, posture, and duration of exposure.<sup>[21]</sup> Concerned with the human limit for rotational tolerance, earlier studies from the 50's focused on optimal angular velocity, putting participants in centrifuges and testing their reactions to specific terminal velocities. This research suggested that human could



only tolerate 3-4 rpm before becoming sick or partially incapacitated. Later studies pointed out that this research failed to consider operational methods for producing greater performance in a centrifuge.<sup>[21]</sup> In 1978, Drs. Graybiel and Knepton of the Naval Aerospace Medical Research Laboratory found that by incrementally increasing angular velocity, and allowing the crew to repetitively perform a series of basic bodily movements at each dwell, participants were essentially able to additively adapt to the motion and Coriolis effects experienced at each stage.<sup>[22]</sup> In fact, subsequent research showed that by using this method of adaptation, the human limit to tolerable rotational rate can actually approach 9-10 rpm rather than the 3-4 rpm that earlier studies had concluded.<sup>[21]</sup>

Nevertheless, just as a high gravity gradient has proven to be safe, the research with incremental centrifugation has simply demonstrated that higher rpm are bearable, if necessary. In the meantime, for safety purposes, a low gravity gradient and slower angular velocity can be considered preferable parameters. Thus, this would imply that a large-radius makes for the ideal AG structure. This is where we decided to take advantage of the scale of our Phobos base.

With a gravitational force approximately half of 1% of Earth's gravity ( $0.0057 \text{ m/s}^2$ ), Phobos can essentially be considered a zero-g environment much like the transit to Mars itself. The difference between being in interplanetary space and being on Phobos is the large surface that is available for use and assistance. Securely anchored into to Phobos' solid core, a large platform with a radius of 90 m towers well above the dusty lunar surface, and makes for the foundation of our base. Consequently, it was decided to install an outward-facing rail along the perimeter of the base to support a train/rollercoaster-like centrifuge system. This rail sits on the outer faces of the vertical support trusses and is located just under the rim of the platform rather than underneath or on top of it, so as to not hinder future expansion efforts or other structures and activities on the platform's surfaces. Originally, the rail was intended for facilitating a single centrifuge module. However, a second module was deemed necessary in order to have balancing masses that would prevent the base from wobbling when in operation. A single spin/de-spin activation system would control both modules (conveniently designated as Modules 1 and 2) so as to maintain equal distances between each other as they simultaneously reach a comfortable terminal velocity of 3 rpm. Given the modules' radial distance from the

center of the base and internal dimensions (12 m in length, 4 m in diameter, and 134 m<sup>3</sup> of volume each), a near-uniform gravity gradient would be present throughout their respective volumes (0.959 g at the head, and 0.976 g at the feet), allowing for greater ease of movement and adaptation.<sup>[23]</sup>

The floors of both modules would be slightly curved with respect to the curvature of the base (see Figures 7 & 8). Ironically, this would help prevent the perception of slopes (inclines and declines), and promote the feeling of a flat environment.<sup>[19]</sup> Both modules would also include a small restroom with toilet and shower in order to provide the opportunity for a more Earthly and familiar alternative to the zero-g restroom experience (Figure 9). The aft walls of both modules are painted red, and the forward walls green, in correspondence to “stop” and “go” traffic conventions and the direction of the modules’ spin motion. These cues, along with the darkness of the grey floors and the lightness of the white ceilings provide crewmembers a constant sense of orientation (Figures 7 & 8).<sup>[24]</sup> Nevertheless, both modules feature small windows near all of the main functional areas to allow the crew a visual reference to the outside environment. By doing so, the crewmembers’ views will match the motion that they are experiencing, thereby mitigating motion sickness.

Operationally, the team of 6 crewmembers preparing to go to Mars will use the centrifuge system each day as part of their training. To get to the modules, they will take a pressurized shuttle from the hab to the spaceport via rail (Figure 3). Once they are inside the spaceport, they will activate the inflatable airlock connecting to Module 2 parked below. The first three crewmembers will egress to Module 2, and then activate semi-rotation, simultaneously retracting the inflatable airlock and summoning Module 1 to the spaceport. Once Module 1 is lined up under the spaceport, the inflatable airlock is then re-activated until the remaining crewmembers (including the designated commander) egress to Module 1 (Figure 4). Each module is laid out such that the crewmembers will enter, immediately turn to their right to form a line, and stabilize their bodies using the handrails installed on the wall next to them (Figures 5 & 6). In Module 1, the commander of the group would instead proceed straight upon entering, in order to reach the workstation located directly across from the hatch. At this workstation, the commander sets the parameters for the crew’s AG session, and then takes position at the forward-most set of handrails where a spin/de-spin remote control box is located. Once here, the commander initiates the commencement of incremental acceleration in accordance to the parameters

set, affecting both modules simultaneously (Figures 5 & 6). The crew of 6 would then follow the additive adaptation method for the AG environment until terminal velocity is reached, at which point they would be allowed away from the handrails to conduct their intended activities. Module 1 would serve as a 1G exercise facility where crewmembers will have access to a treadmill, a cycle ergometer, and a full cable machine set, the latter of which would be located at the center of the module so as to provide the intended g-level as accurately as possible while training extended limbs. Meanwhile, Module 2 will serve as a high-fidelity training ground where crewmembers will have access to virtual reality (VR) headsets and supplemental equipment in order to learn, practice, and prepare for their mission on Mars.

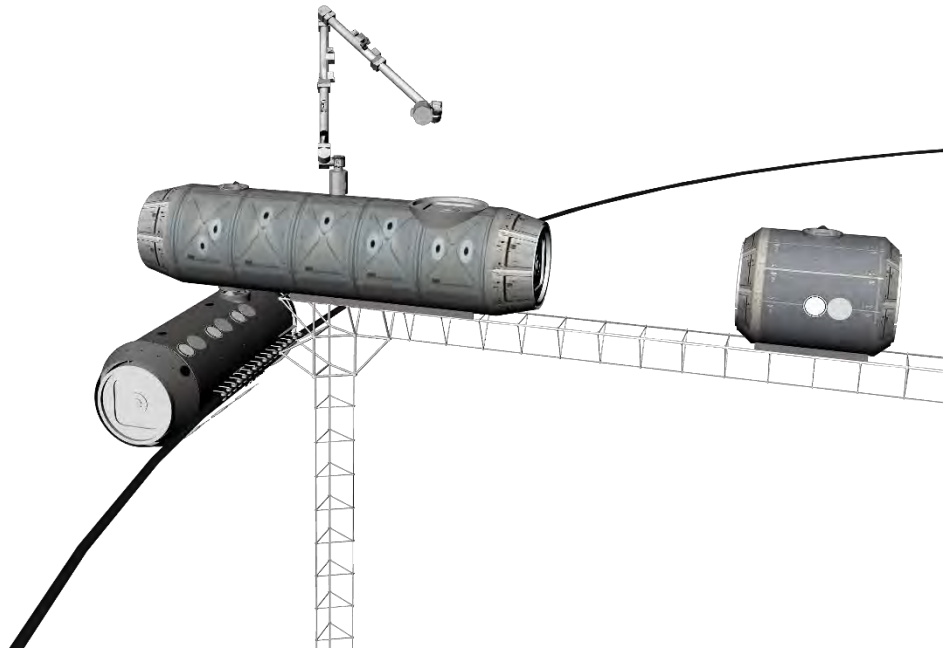

*Figure 26: Module 2 parked underneath the spaceport, while crew arrive at the spaceport via pressurized shuttle*

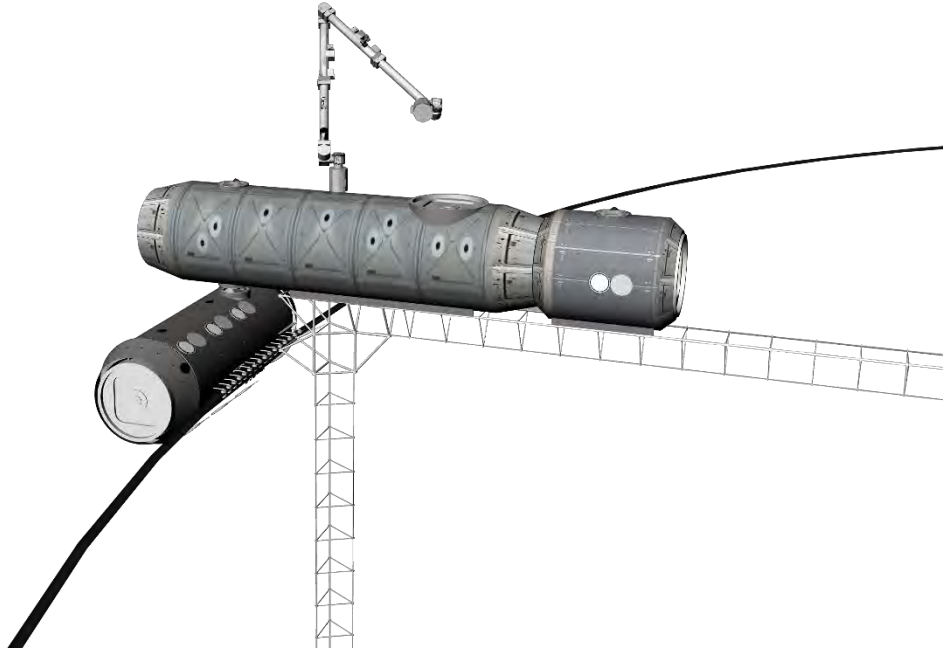

Figure 27: Shuttle docked; Module 1 parked underneath the spaceport

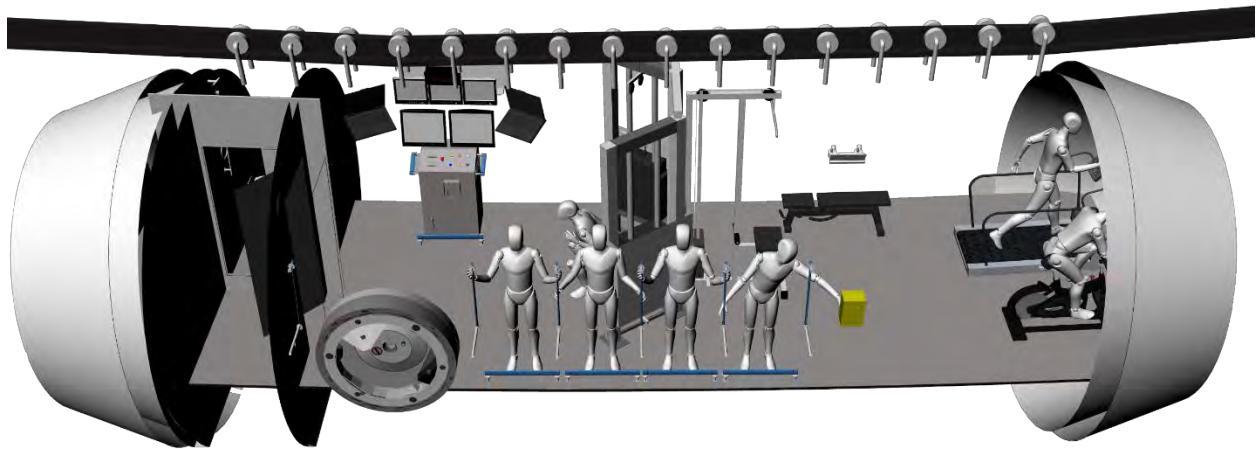

Figure 28: Top view of Module 1. (Note: each module is designed to accommodate up to 4 crewmembers. However, more than 4 crewmembers are depicted here and in the following figures to demonstrate their actions at each functional area)

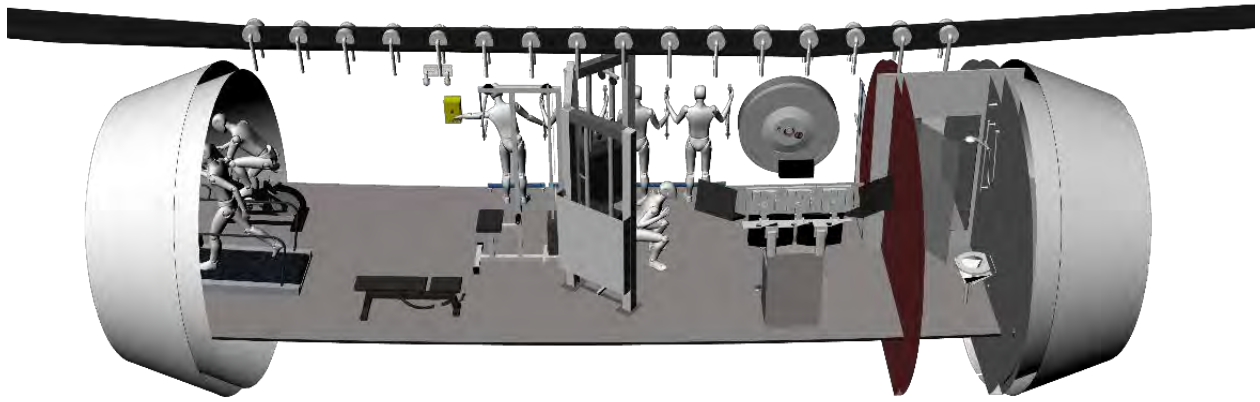

Figure 29: Bottom view of Module 1

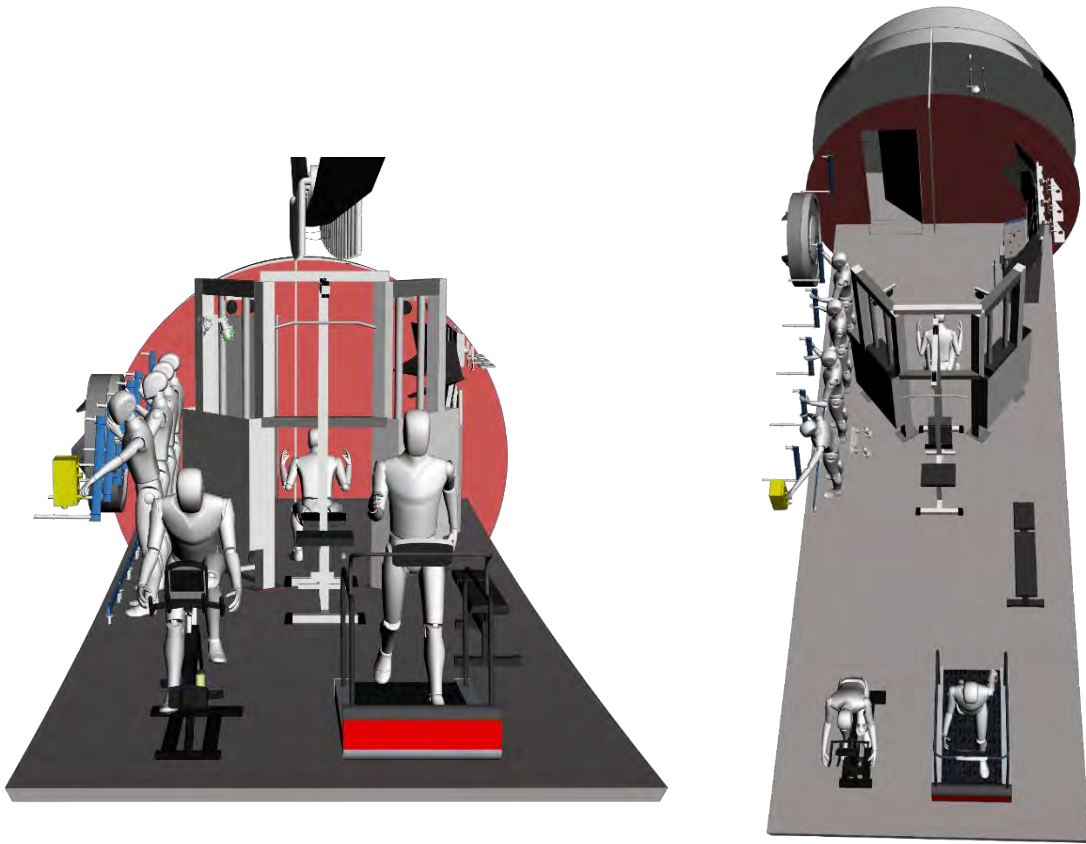

Figure 30: Forward view of Module 1

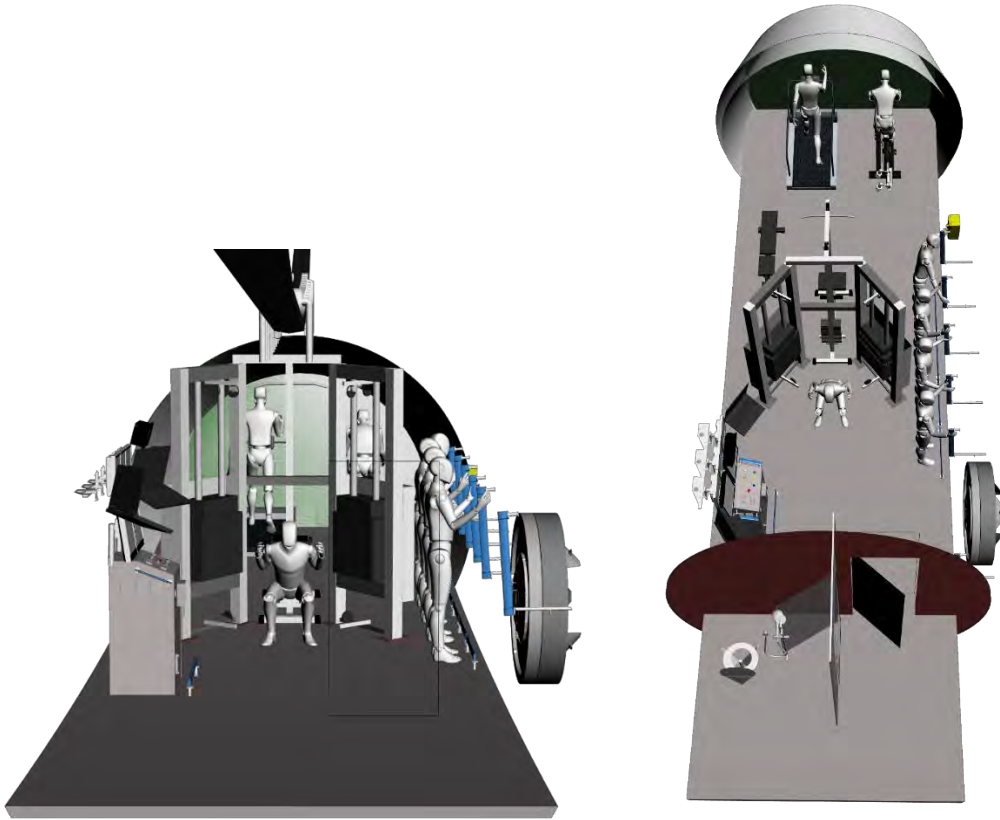

Figure 31: Aft view of Module 1



*Figure 32: The restroom installed on both Module 1 and Module 2 feature a detachable showerhead so as to allow crewmembers complete control of the flow of water in response to the unnatural Coriolis effects*

## 9.2 Radiation

Phobos is tidally synchronized to Mars, meaning that the same side faces the planet at all times. Phobos also possesses a nearly circular orbits very close to its parent planet, 6,000 kilometers above the Martian surface, within a few degrees of the equatorial plane. <sup>[25]</sup> <sup>[26]</sup> This coupled with the size of Stickney Crater, about 9km wide and 22km deep, means the Phari base would be offered an almost unprecedented amount of radiation protection from galactic cosmic rays (GCRs) and solar energetic particles (SEPs) simply being shielded by both planetary bodies. <sup>[27]</sup> It has been proposed that any object positioned inside Stickney Crater would be shielded from as much as 90% of galactic cosmic radiation, with an increase to that percentage of the base were placed on the west side of the slope. <sup>[28]</sup> That same source goes on to say even the general surface of Phobos facing Mars (outside of Stickney) the cosmic ray shielding would be about 75%, still an impressive figure. These figures would be the same in the event of a solar energetic particles emitted by our sun.

For added protection from solar storms, an estimated 16cm of regolith is required, assuming the composition is anywhere similar to Martian regolith. <sup>[29]</sup> The other most likely material composition of Phobos

would be Type I or II carbonaceous chondrites, the material that makes up asteroids and dwarf planets.<sup>[26]</sup> Because the composition of the planet is unknown, it was decided to go with polyethylene bricks to serve as added radiation protection in the base, specifically in the safe room of the habitat. According to a 2006 study, 'bricks' of polyethylene inserted into the chamber walls of a spacecraft only 5cm thick would be enough to shield the crew in the case of solar energetic particles.<sup>[30]</sup> These bricks would come at a cost of thicker walls and more weight (an added 2,144.25 grams) , so the safe room is located in the command module of the hab on the bottom three full floors, **as seen in figure X below**..<sup>[31]</sup>

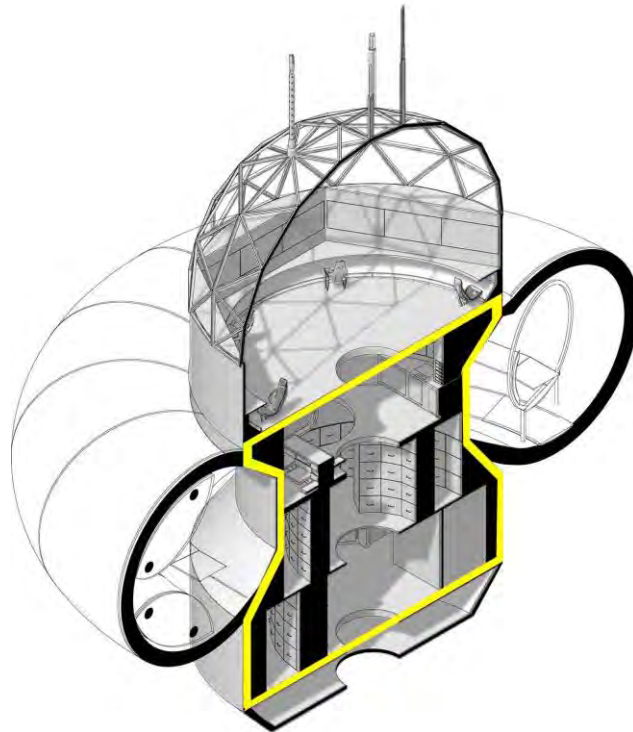

*Figure 33: Yellow border showing the extent of the safe room*

This safe room contains two restrooms, storage of temporary sleeping bags, as well as the galley and primary stowage for food. Solar storms typically last only a several minutes to a few hours but the effects of these storms can linger in anywhere with a magnetosphere and atmosphere for days to weeks. While Phobos has neither a magnetosphere or atmosphere, it does rotate extremely close to Mars's atmosphere. The safe room



is designed to contain crew for a maximum of four days as an added redundancy until the lasting effects of solar energetic particles are understood.

### 9.3 Dust & Contaminants

Because of the small scale, low gravity vector, and location of our base, human EVA excursions would be kept to a minimum. The Stickney Crater interior and immediate outer rim contains the most scientifically interesting point of study, which could be achieved in very few and easy robotic drones. Should the need for human supported EVA be required, the use of Suitports would further mitigate any large introduction of dust or contaminants to the Phari interior atmosphere, shown in [figure X](#).

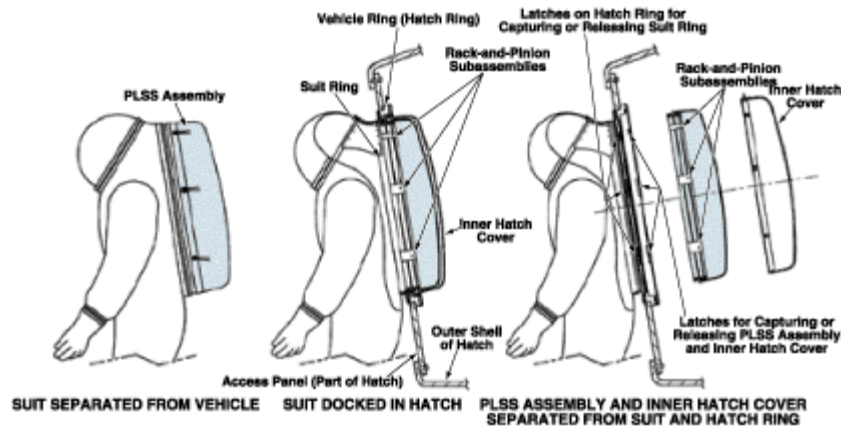

Figure 34: Ames Research Center

A suitport is a rear-entry space suit which is attached and sealed against the outside of a spacecraft, space habitat, or rover. Mass and volume required for a suitport would be significantly less than that required for a traditional airlock and eliminates or minimizes the problem of dust mitigation.

### 9.4 Planetary Protection

In the main 'node floor' of the support module, there is only one node connecting the spaceport to the main Phari Habs that contains an airlock with a separate entrance to the astrobiology lab. The astrobiology lab is a self-contained section of the module that is compatible with bio isolation level 4 and offers two methods of

sterilization of any unwanted contaminants. Though only two methods were finally employed, four methods of biological sterilization were examined;

*Passive sterilization through UV radiation:* Highly effective against many microorganisms, but not all, as a *Bacillus* strain found in spacecraft assembly facilities is particularly resistant to UV radiation. This would be the primary method of eliminating bacteria, but cannot be the only method. UV radiation is only effective when all surfaces are exposed to the light. Objects with complex geometry, such as EVA equipment with tightly compacted hardware, would be difficult to sterilize and well as any surfaces or materials covered in dust, as the UV radiation may be unable to penetrate bacteria underneath it.

*Hydrogen Peroxide (vapour phase):* Very effective, but can affect finishes, lubricants and materials that use aromatic rings and sulfur bonds. It could only be used in small, contained, spaces, such as pressurized containers only a meter or so large. The astrobiology lab proposed would be too large to employ this method effectively without compromising the material integrity of the airlocks or scientific equipment in the lab.

*Ethylene oxide:* This is widely used in the medical industry, and can be used for materials not compatible with hydrogen peroxide. It was decided to use this in a vapor phase, which would allow the ethylene oxide to reach interior grooves and holes of complex spacecraft. *Supercritical carbon dioxide:* The most effective against traces of organic compounds rather than whole microorganisms. The only drawback of this method is the process can leave organic traces that can confuse life detection instruments and it was for this reason not included as a final proposal.

## 10.0 Arrival of Crew

### 10.1 Crew Transfer From Interplanetary Vehicle (IPV)

The crew will arrive at the Spaceport which is equipped with common berthing hatches and standard docking hatches. This is to ensure that a standard is kept throughout the design of future spacecraft. Once the crew ingress through the hatch to the Spaceport, they will make their way to the shuttle module where it will be docked waiting for them. The shuttle will then transport the crew to the main facility where they will go through a quarantine hatch. This hatch directly interfaces with the astrobiology lab and if the crew have had contact with extra-terrestrial objects, they must make their way to the lab for decontamination and sample drop off. Likewise, the quarantine hatch is equipped with its own decontamination equipment for the traveler coming from Earth.

### 10.2 Process of base activation and verification

As previously stated in section 6.0 Base Assembly & Construction, Phari base will be assembled in LEO. Due to the lengthy time taken to assemble the base, it makes sense to utilize the time wisely and have crews on board systematically checking for functionality of all the systems. During the six year assembly process, the crews will perform functionality checks of all the systems and sub-systems. They will also maintain and repair any hardware that malfunctions or fails; mission control teams will troubleshoot problems that arise and strive to find permanent solutions to these issues. With crews on orbit and a close proximity to Earth, repairs can be made within a matter of weeks.

The crews on orbit will also be able to test some of the unique functions of the base such as growing plants for food. Growing plants will be very crucial to the success of the mission, testing out the new plant growing facilities gives the crew and the ground personnel data on how well the plants are doing. Testing will also be conducted in the greenhouse to survey the performance of the airflow, light generation, plant growth and fertilizer production. This data is very important as tweaks to the system can be made on the fly by ground teams and crew to ensure the most optimal sustained growing conditions.

The alternative to verifying the base systems at LEO is to assemble the base in LEO and send the base dormant to Phobos. For this trade study we evaluated the above plan to verify in LEO against the plan to verify in Phobos. The criteria we believe is critical in making this decision are:

- Probability of hardware failure during systems initiation
- Access to resources for repair / troubleshooting
- Dangers to the crew
- Launch vehicle usage

Verifying base functionality and systems operation on Phobos has many disadvantages. First, there is no guarantee that the hardware onboard will operate as it did prior to launch. Leaving the base in a dormant state unmonitored will lead to unexpected anomalies; from professional experience in the ISS program, it's been observed that hardware that is tested on the ground can fail in orbit for quite a number of reasons. Things simply behave differently in space in unexpected ways.

Second, repairing anomalies after verification will put an impact on the spares allocation. The base is only equipped with a finite supply of spare hardware and to use some of it right at base initialization will only seek to hinder future repair work. Although there is a workshop on base and fabrication can make new parts, if these issues were discovered while in LEO, the spares allocation and fabrication material allocation would not be impacted right at the beginning of the mission.

Third, if the crew are to travel by other means then this adds complexity to the logistics of the mission. There are two vehicles that must be planned for and two sets of resources (food, water, air). The IPV will be used to transport the crew, however the issue of landing the base on Phobos poses another risk.

Using robotics for base landing operations may lead to an unmanageable amount of variables and unknowns. Some potential issues are malfunctions in the GPS network, base computer does not initiate correct command sequence, camera's fail, engines burn for the incorrect amount of time. Exposure to ISS program FIT meetings has educated a member of the SICSA team in the many software issues that occur on the ISS; it would be naïve to assume that none of these types of issues will not happen on this Phobos mission. The risk

to the mission is also too great, considering this base will easily cost billions of dollars and weigh about 300 metric tons.

Furthermore, food production is vital to the continued presence of the crew on Phobos. Inadequate testing of plant growing systems during the space flight to Phobos presents additional unknown for the crew if they will be able to grow foods on Phobos. The greenhouse is a delicate micro ecosystem and sub systems such as the compost bins that house worms will have to be stored and maintained on the IPV in order to remain usable once arriving at Phobos. Thus, this increases the volume of the IPV which in turn increases the mass and propellant needed to travel to Phobos.

It is clear that verifying the base on Phobos is a very risky process. The limited human interaction is unlikely to garner confidence in mission planners and integrators. Humans are still the best resource for space travel and should be utilized to the fullest extent. Finally, the proximity to Earth should be taken advantage of for as long as possible, giving the Phobos crews the best chance at success.

### 10.3 Further Assembly, Construction, Outfitting

The evolution of the outpost will have to go through the arrival of a processing facility, or ISRU module, this will be the main evolution that the base will go through. Other modules will join while the use of the station as a fueling station increases, the base is expected to increase its food production with additional greenhouse modules and its storage capacity with multiple fuel depots.

## 11.0 Concept of Operations



*Figure 35: Operational Phari base*

### 11.1 Completed Base

Phari base once completed will act a stop on the way to Mars in phase 1, the centrifuge will be used to acclimate the future Martian explorers to Martian gravity (0.38 G), a rotating crew of 6 will be enough to maintain and operate the base on a regular schedule. Experiments will be conducted on the Phobos surface to assess the feasibility of industrial scale fuel production. Training based on Mars observation will be devised and done on Phari to ensure that all crews are ready for their next journey. In phase 2 when refueling of incoming ships will be possible, harvesting and processing of water will be part of a regular schedule for the crew. Arrival of new crew will happen on a regular basis, this new crew will cohabit with the experienced team for a couple of weeks for training purposes and will replace them in time when the A team will land on Mars or return home after a successful mission.

## 11.2 Unique Systems

### *11.2.1 Shuttle*

The shuttles uses an independent ECLSS system, have 2 windows, 2 common berthing mechanism and one international port on the top for emergency rescue. It will transport power, water, cargo and crew. They will move along the trusses axis using an Active Wheel system,, connecting to the support module ports and transferring their cargo. <sup>[32]</sup>

### *11.2.2 Rover*

The exploration rover is based on NASA's Space Exploration Vehicle., Ffor further explanation on Phobos surface operations please refer to Chris Gebhardt presentation. <sup>[33] [34]</sup>

### *11.2.3 Robotic arm*

Dimensions and capacities are based on Canadarm2. <sup>[35]</sup> The two arms present on the station, one on the spaceport and one that will be mounted depending on the mission will be powered by the modules themselves. A Mobile Transporter will be used in certain cases, it will run along the trusses and carry the robotic arm.

### *11.2.4 Surgical robot*

The medical bay features a robotic surgical device that is ceiling mounted. The ceiling mount allows the robot to glide along the tracks perpendicular to any human laying below it. The arm is bi-directional in the X and Y axis. At the end of the arm is a half circle with two laser precision limbs that is the actual point of contact between the human and the machine.

The surgical robot is programmed from a wall-mounted digital display that allows users to access medical diagnostics. This display can suggest solutions for medical emergencies based on a mix of provided medical information and a physical can that all crew members must submit on heir way to the Phari base. Because of its laser guidance system, the device is accurate enough for most surgical procedures.

### 11.2.5 Geodesic dome

The top portion of the Command Module features a half spherical geodesic dome. This allows for each pane of glass to be flat, a more secure method of construction, instead of having bent panes of glass to achieve a dome shape. The aluminum metal support structure is an equally mirrored on all sides, so the pressure is distributed evenly. This also eases the method of manufacturing, as every surface of the entire dome is flat, not bent.

The glass is made of a transparent aluminum that offers greater protection against micro-meteorite impacts than traditional high-performance or borosilicate glass. The transparent property of the glass makes critical visual observation necessary for Mars observation and flight assist control for incoming spacecraft. As viewed externally, the dome would be a shining beacon for easy visual identification when the Stickney Crater is in shadow.

## 11.3 Space Port

The goal of having a spaceport disconnected from the main base is to prevent any kind of incoming ship to impact the main habitat and therefore to put the crew's life in danger. The spaceport is a hub that intends to connect the centrifuge module and the incoming spaceships with the rest of the base through a shuttle that will ferry astronauts and cargo. The spaceport will have a robotic arm just like Canadarm2, [13], one common berthing mechanism on top, 2 on the opposite sides, 1 international port on top and the last port will have an expandable port that will be similar to the international port but with expandable capabilities to ensure a safe rotation for the centrifuge.<sup>[35]</sup>



## 12.0 Future Base Expansion

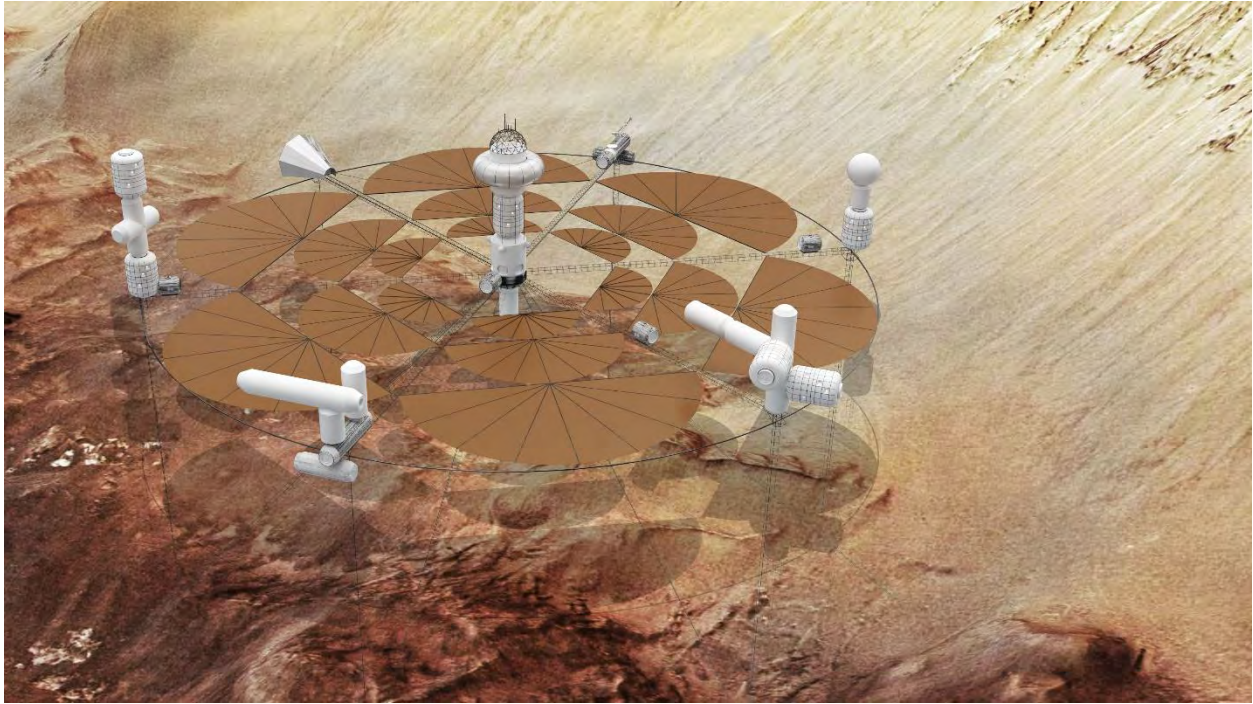

*Figure 36: Possible expansion of the base*

This base will act as a resupply point for all kinds of exploration missions. It will act as a safe haven from the strong radiations and will be able to train the future explorers for Martian surface operations, using its centrifuges and its instruments aimed at Mars base.

The first module to complement the initial phase of the base will be a processing facility, it will expand on the discoveries of the astrobiology lab and workshop. It will reiterate the processes experimented in those modules but on a much bigger scale. Phase 2 will see the arrival of another habitat module and greenhouse, coupled with another spaceport. The expansion of the base will follow the discovery or not of large amount of mineable material on Phobos.

From then on, the future phases will depend on the success of the processing facility and its experiments. If the discovery, mining and processing of water or other materials on Phobos is successful, more processing modules will be sent and other fuel tanks too. In case that process is unsuccessful, most of the future modules will be habitat modules and greenhouses.

## 13.0 Critical Technology TRL

- Truss
  - Carbon fiber rods - 6
  - Gripper - 6
- Energy
  - Nuclear - 6
  - Solar - 9
- Launch
  - SLS - 6
  - Falcon heavy - 6
- Greenhouse
  - Omega Garden™ - 6
  - Inflatable torus - 4
- Centrifuge
  - Michelin active wheel - 6
  - Rail - 9
  - Expandable port - 7
- Aluminum glass - 9
- VASIMR - 6
- ISRU
  - Fuel depot - 3
  - Electrolysis - 9
  - Robot digger - 6
- EVA
  - Suits - 9
  - Exploration - 6

## 14.0 Conclusion

The Phari Base design proposal is based on experiences from the ISS and emerging technologies that have good potential for space applications e.g. operations on celestial bodies with extremely low gravity such as Phobos. Those include gripping mechanisms for Phobos surface attachment located on the Phari's trusses, rotating greenhouse elements, nuclear power supply, and centrifuge exercising facility. The team's choice to use crew safety, health maintenance and operational sustainability as major design decision-making factors led to several essential assumptions and development of Phari's unique elements: deployable trusses in combination with protective and deployable platform that supports spaceport facility and railing system to enable centrifuge element rotating. The design for this base provides for a range of solutions to the problems posed by that extreme environment but many parameters are still unclear and can't be addressed in that exercise.

This project provides for a clear and practical proposal for a human outpost in partial gravity, vacuum environment that is Phobos but requires extensive studies and testing. Please consider this proposal as recommendation for best architecture based on actual knowledge of technology and environment.

Thank you

## 15.0 References

- [1] Christiansen, E. L., & Lear, D. M. (2012, February). *Micrometeoroid and Orbital Debris Environment & Hypervelocity Shields*. Retrieved from <https://ntrs.nasa.gov/archive/nasa/casi.ntrs.nasa.gov/20120002584.pdf>
- [2] Atkinson, N. (2015, December 23). An Inside Look at the Water/Urine Recycling System on the Space Station. *Universe Today*. Retrieved from <https://www.universetoday.com/101775/an-inside-look-at-the-waterurine-recycling-system-on-the-space-station/>
- [3] National Aeronautics and Space Administration (2010). *Closing the Loop: Recycling Water and Air in Space*. Retrieved from [https://www.nasa.gov/pdf/146558main\\_RecyclingEDA%28final%29%204\\_10\\_06.pdf](https://www.nasa.gov/pdf/146558main_RecyclingEDA%28final%29%204_10_06.pdf)
- [4] Geutersloh, S., Zeitlin, C., Heilbronn, L., Miller, J., Komiyama, T., Fukumura, Y., ... Bhattacharya, M. (2006). Polyethylene as a radiation shielding standard in simulated cosmic-ray environments. *Nuclear Instruments and Methods in Physics Research*, 252, 319-332. doi:10.1016/j.nimb.2006.08.019
- [5] Straume, T., Blattnig, S., & Zeitlin, C. (2010). Radiation Hazards and the Colonization of Mars: Brain, Body, Pregnancy, In-Utero Development, Cardio, Cancer, Degeneration. *Journal of Cosmology*, 12, 3992-4033.
- [6] Ilin, A. V., Cassady, L. D., Glover, T. W., Chang Diaz, F. R. (2011, March). *VASIMR® Human Mission to Mars*. Paper presented at the Space, Propulsion & Energy Sciences International Forum, University of Maryland, College Park, Maryland, USA.
- [7] BC SpaceX (2017). *Falcon 9*. Retrieved from <http://www.spacex.com/falcon9>
- [8] Berger, E. (2017, March). Blue Origin releases details of its monster orbital rocket. *Ars Technica*. Retrieved from <https://arstechnica.com/science/2017/03/blue-origin-releases-details-of-its-monster-orbital-rocket/>
- [9] Wall, M. (2016, April). Private Space Habitat to Launch in 2020 Under Commercial Spaceflight Deal. *Space*. Retrieved from <http://www.space.com/32541-private-space-habitat-launching-2020.html>
- [10] National Aeronautics and Space Administration (2003). *International Space Station (ISS) Flight Systems*. Retrieved from [https://www.nasa.gov/pdf/167129main\\_Systems.pdf](https://www.nasa.gov/pdf/167129main_Systems.pdf)
- [11] Levine, H. G. (2010, August). *The Influence of Microgravity on Plants*. Powerpoint presented at the 2010 NASA ISS Research Academy and Pre-Application Meeting, League City, TX.
- [12] Carrasquillo, R. (2013, July). *ISS Environmental Control and Life Support (ECLSS) Future Development Exploration*. Powerpoint presented at the 2<sup>nd</sup> Annual ISS Research and Development Conference, Denver, Colorado, USA.

- [13] BIOS-3 (2017.) Retrieved from <http://www.biosmhars.eu/expe/bios-3>
- [14] National Aeronautics and Space Administration (2008). *NASA Facts: International Space Station Environmental Control and Life Support System*. Retrieved from [https://www.nasa.gov/sites/default/files/104840main\\_eclss.pdf](https://www.nasa.gov/sites/default/files/104840main_eclss.pdf)
- [15] Murchie, S. L., Thomas, P. C., Rivkin, A. S., & Chabot, N. L. (2015). Phobos and Deimos. In P. Michel, F. E. DeMeo, & W. F. Bottke, *Asteroids IV*. University of Arizona Press.
- [16] Space Exploration (2017). *Air temperature and humidity inside the ISS*. Retrieved from <https://space.stackexchange.com/questions/2539/air-temperature-and-humidity-inside-the-iss>
- [17] HyperPhysics (2017). *Electrolysis of Water*. Retrieved from <http://hyperphysics.phy-astr.gsu.edu/hbase/thermo/electrol.html>
- [18] Hargens, A. R., Bhattacharya, R., & Schneider, S. M. (2013). Space physiology VI: exercise, artificial gravity, and countermeasure development for prolonged space flight. *European Journal of Applied Physiology*, 113, 2183-2192. doi:10.1007/s00421-012-2523-5
- [19] Hall, T. W. (2006). *Artificial Gravity, Visualization, Empathy, and Design* (AIAA 2006-7321). San Jose, California, USA: American Institute of Aeronautics and Astronautics
- [20] Diamandis, P. H. (1988). *The Artificial Gravity Sleeper: A Deconditioning Countermeasure for Long Duration Space Habitation* (Master's thesis). Retrieved from MIT Libraries.
- [21] Lackner, J. R., & DiZio, P. (1998). Adaptation in a rotating artificial gravity environment. *Brain Research Reviews*, 28 (1-2), 194-202. doi:10.1016/S0165-0173(98)00039-3
- [22] Lackner, J. R., & DiZio, P. (1998). Adaptation in a rotating artificial gravity environment. *Brain Research Reviews*, 28 (1-2), 194-202. doi:10.1016/S0165-0173(98)00039-3
- [23] Hall, T. W. (2000). SpinCalc [Computer Software]. Retrieved from <http://www.artificial-gravity.com/sw/SpinCalc/>
- [24] Hall, T. W. (1997, March). *Artificial Gravity and the Architecture of Orbital Habitats*. Paper presented at the 1<sup>st</sup> International Symposium on Space Tourism (ISST), Bremen, Germany.
- [25] Dunford, B. (2017). *NASA Science: Solar System Exploration*. Retrieved from <https://solarsystem.nasa.gov/planets/>
- [26] Redd, N. T. (2016, June). Phobos: Facts About the Doomed Martian Moon. *Space*. Retrieved from <http://www.space.com/20346-phobos-moon.html>

- [27] Jha, N. (2016, October 14). Scientists solve the mystery behind Stickney crater on Phobos. *International Business Times*. Retrieved from <http://www.ibtimes.co.in/scientists-solve-mystery-behind-stickney-crater-phobos-699599>
- [28] Straume, T., Blattmig, S., & Zeitlin, C. (2010). Radiation Hazards and the Colonization of Mars: Brain, Body, Pregnancy, In-Utero Development, Cardio, Cancer, Degeneration. *Journal of Cosmology*, 12, 3992-4033.
- [29] Simonsen, L. C., & Nealy, J. E. (1991). *Radiation Protection for Human Missions to the Moon and Mars* (NASA-TP-3079). Retrieved from [https://www.hq.nasa.gov/office/pao/History/alsj/WOTM/NASA\\_TP\\_3079.pdf](https://www.hq.nasa.gov/office/pao/History/alsj/WOTM/NASA_TP_3079.pdf)
- [30] Geutersloh, S., Zeitlin, C., Heilbronn, L., Miller, J., Komiyama, T., Fukumura, Y., ... Bhattacharya, M. (2006). Polyethylene as a radiation shielding standard in simulated cosmic-ray environments. *Nuclear Instruments and Methods in Physics Research*, 252, 319-332. doi:10.1016/j.nimb.2006.08.019
- [31] Sepe, M. (2012, May). Density & Molecular Weight in Polyethylene. *Plastics Technology*. Retrieved from <http://www.ptonline.com/columns/density-molecular-weight-in-polyethylene>
- [32] Neiger, C. (2017, January). How In-wheel Motors Work. *HowStuffWorks Auto*. Retrieved from <http://auto.howstuffworks.com/in-wheel-motor2.htm>
- [33] National Aeronautics and Space Administration (2010). *NASA Facts: Space Exploration Vehicle Concept*. Retrieved from [https://www.nasa.gov/pdf/464826main\\_SEV\\_Concept\\_FactSheet.pdf](https://www.nasa.gov/pdf/464826main_SEV_Concept_FactSheet.pdf)
- [34] Gebhardt, C. (2015, July). Mission to Phobos – The precursor to human Mars landing. *NASA Spaceflight*. Retrieved from <https://www.nasaspaceflight.com/2015/07/mission-phobos-precursor-human-mars-landing/>
- [35] Kauderer, A. (2013). *International Space Station: Space Station Assembly*. Retrieved from [https://www.nasa.gov/mission\\_pages/station/structure/elements/mss.html](https://www.nasa.gov/mission_pages/station/structure/elements/mss.html)

### Appendix A, B, C

These appendices will have all the equations behind the calculations and estimates that have gone into the rationale behind each decision of the base design.

Total pressurized volume (cubic meters)=  $2,300 + 220 + 230 = 2750$

Volume on the ISS