

# Cairo University

## AIAA 2021-2022 DBF Competition Proposal

### 1.0 Executive Summary

This proposal demonstrates the UDC, Unmanned aerial systems Development Center, team’s planned approach in meeting this year’s mission requirements. The team’s objective this year, in response to the AIAA guidelines, is to design and manufacture a functional UAV capable of delivering and deploying delicate vaccination components.

In fulfilling this objective, the missions along with the design constraints and scoring criteria were thoroughly studied. As a result, the maximum takeoff distance of **25 ft**, the **100 Watt-hr** total stored energy constraint, along with the multiple power-consuming-taking-off and landing requirement, defined three design requirements for this year’s aircraft: lightweight, low-stall speed, and low drag. Moreover, taxing represents a crucial phase in mission three profile, necessitating a reliable landing gear and steering system design.

Furthermore, the scoring criteria implied that apart from the design report and the constraints-driven design requirements, maximizing the score imposes two additional design parameters: high payload capacity and high cruising speed. This is due to the strong score dependence on payload maximization and lap-time minimization. To ascertain the most impacting parameter, the team performed a comprehensive sensitivity analysis, which confirmed that the high payload capacity in both missions is the most affecting parameter, followed by the ground mission time.

Accordingly, a tractor single-motor conventional high-wing aircraft with a conventional empennage and tricycle landing gear was chosen. This UAV is designed to cruise up to **131.23 ft/s**, carry **70** syringes in **M2**, and accommodate **5** vaccine vial packages in **M3**. The wing will be made of composite materials to bear the imposed high payload stresses, while the remaining parts will utilize the build-up balsa method with some composite reinforcements. The aircraft’s subsystems will be individually tested for performance, rigidity, and reliability.

The subsequent sections feature the team’s structure, the project’s plan, and the estimated budget followed by the conceptual design phase attributes: mission analysis and sizing. Afterward, the manufacturing methodology and testing plan are discussed in detail.

### 2.0 Management Summary

#### 2.1 Team Organization

The team consists of two faculty advisors, a post-grad chief engineer, and 16 undergraduates: six seniors, ten juniors. In addition, it’s planned that  $x$  sophomores join the team in mid-November, based on their work in the local DBF competition. This merge of varying expertise ensures the flow of experience among the lab members and the accumulation of the knowledge gained with each new participation in the competition.

#### 2.2 Organization Description

The team’s hierarchical structure, illustrated in *figure 2.1*, facilitates the communication between all members and ensures an efficient work distribution.

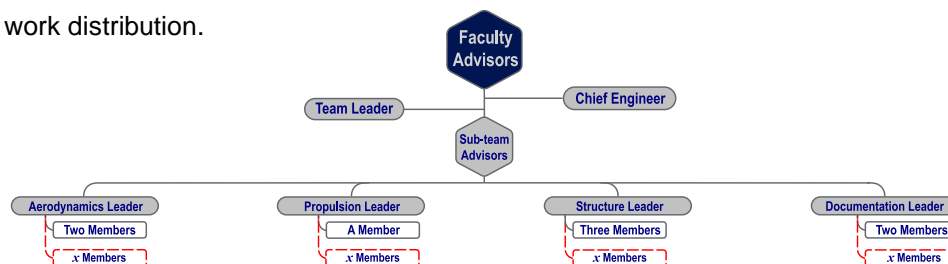

*Figure 2.1: Team's Organizational Chart*

The two faculty advisors monitor the project progress and offer consultation in major decisions. The chief engineer offers advice and guidance to resolve conflicts. The team leader is an elected junior who assigns the tasks to the sub-teams and ensures a punctual workflow. The sub-team advisors are experienced members who offer vital technical consultation in the respective fields.

The sub-team leaders are responsible for the up-close management of each sub-team and the reporting of the sub-team progress to the team leader. In a weekly meeting, the progress is discussed, and any suggested ideas are thoroughly studied. Before making the final decision, the team leader consults the faculty advisors and the chief engineer. The roles and the required skillset for each sub-team are shown in *table 2.1*.

*Table 2.1: Sub-teams responsibilities and skillset*

Sub-team	Responsibilities	Required Skillset
<b>Aerodynamics</b>	<ul style="list-style-type: none"> <li>conducting A/C sizing, stability, and performance analysis</li> <li>optimizing the MATLAB sizing framework</li> </ul>	<ul style="list-style-type: none"> <li>solid knowledge of MATLAB tools</li> <li>familiarity with high and low fidelity aero tools</li> </ul>
<b>Structure</b>	<ul style="list-style-type: none"> <li>designing and manufacturing the A/C structure and mechanisms</li> <li>performing structural analysis, tests, and simulations</li> </ul>	<ul style="list-style-type: none"> <li>solid knowledge of structural analysis</li> <li>ability to use CAD and FEA software</li> <li>grasp of manufacturing &amp; machining techniques</li> </ul>
<b>Propulsion</b>	<ul style="list-style-type: none"> <li>optimizing the MATLAB propulsion sizing framework and performing various propulsion tests</li> </ul>	<ul style="list-style-type: none"> <li>familiarity with MATLAB tools</li> <li>solid knowledge of propulsion systems</li> </ul>
<b>Documentation</b>	<ul style="list-style-type: none"> <li>documenting the project concisely</li> <li>designing clear illustrations and figures</li> </ul>	<ul style="list-style-type: none"> <li>grasp of technical writing skills</li> <li>familiarity with graphic design software</li> </ul>

### 2.3 Schedule | Major Milestone Chart

A Gantt chart, shown in *figure 2.2*, is made to streamline the workload, highlight the key milestones for each phase, and keep track of the actual team progress versus the scheduled one, which ensures sticking to the major deadlines.

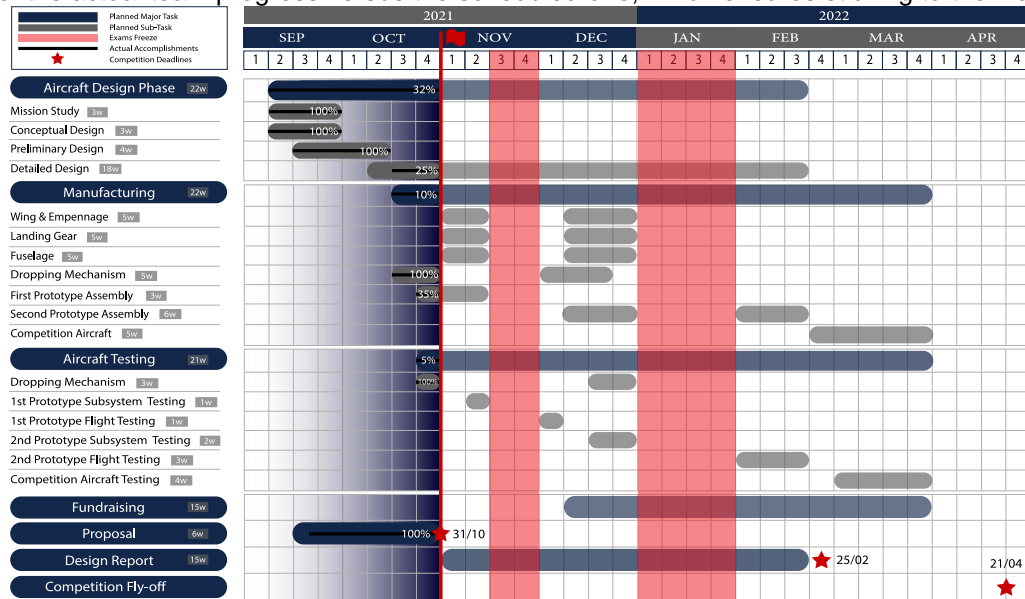

*Figure 2.2: Team's Milestone Gantt Chart*

### 2.4 Budget

This year's budget, shown in *table 2.2*, is based on the analysis of the expected expenses accompanying manufacturing the final fly-off aircraft and its prototypes, as well as the travel and accommodation expenses for the team to attend the fly-off. The team's prior knowledge and the latest market price were considered while making those preliminary estimations for the materials, quantities, and overall cost of this year's design. In order to cover the needed expenses, the team fundraising committee acquired Cairo University and the "Egyptian academy of scientific research and technology" funding programs, and further funds will be pursued after the first prototype's flight testing. To cut the required shipping cost, the A/C will be modular to fit inside the team's luggage. Moreover, all the required machining will be done at UDC fab lab's 3D printers, laser-cutters, 4-axis CNC hotwire-cutters, hand and power tools.

*Table 2.2: Team's Estimated Budget*

Manufacturing materials		Electronics		Travel & Accommodation	
5x Balsa   Plywood sheet	60\$	2x Electric motor	250\$	US visa fees for 6 members	1,150\$
20x Styrofoam   XPS Foam sheet	150\$	2x ESC	350\$	Flight tickets for 6 members	4,800\$
4x 3D-printing ABS Filament	100\$	1x Transmitter   receiver	400\$	Car rental for 10 days	950\$
5x Carbon fiber rod	300\$	10x Main battery pack	250\$	Fuel for 10 days	300\$
3x MonoKote roll	90\$	20x Servomotor	60\$	Lodging for 6 members for 10 days	3,300\$
Fiberglass   resin	280\$	<b>Total</b>	<b>1,310\$</b>	Food for 6 members for 10 days	550\$
Adhesives   Bolts   Nuts	50\$			<b>Total</b>	<b>11,050\$</b>
<b>Total</b>	<b>1,030\$</b>				
<b>Total Estimated Budget</b>				<b>13,390\$</b>	

### 3.0 Conceptual Design

#### 3.1 Analysis of Mission Requirements

This year's aircraft should deliver and remotely deploy vaccination components. The designed aircraft shall perform three flight missions and a timed ground mission. The mission requirements, scoring criteria, and the imposed design constraints by each mission are summarized and translated into the individual subsystem requirements shown in *table 3.1*.

Table 3.1: Mission and Subsystem Requirements

	Mission	Payload	Flight Window	Mission Profile	Scoring Criteria	Subsystem Requirements
Flight Missions	Deployment Flight	No payload	5 min.	• Completing three laps	1.0 for successful mission	<ul style="list-style-type: none"> <li>Minimizing stall speed for fast taking-off</li> <li>Designing a structurally reliable landing gear and steering system for taxiing</li> <li>Designing a reliable mechanism for fast and gentle deployment of a single package at a time</li> <li>Minimizing drag and designing an efficient propulsion system to maximize the A/C speed while fulfilling the multiple power-consuming takeoffs in <b>M3</b></li> <li>Minimizing A/C empty weight and maximizing internal capacity</li> <li>Designing an easily accessible aircraft storage space for fast payload loading/unloading</li> </ul>
	Staging Flight	Syringes	5 min.	• Completing three timed laps	$1 + \frac{N\_syringes/time}{Max\_syringes/time}$	
	Vaccine Delivery Flight	Vaccine vial packages	10 min.	<ul style="list-style-type: none"> <li>Landing anywhere after the final turn</li> <li>Taxiing to the designated drop area</li> <li>Deploying, remotely, a single package without tripping the 5g shock sensor</li> <li>Taxiing across the start/finish line,</li> <li>Coming to a complete stop</li> <li>Taking-off and repeating the cycle</li> </ul>	$2 + \frac{N\_successful\_deployments}{Max\_successful\_deployments}$	
Ground Mission	Both <b>M2</b> and <b>M3</b> payload	Both <b>M2</b> and <b>M3</b> payload	None	<ul style="list-style-type: none"> <li>Loading/unloading <b>M2</b> payload</li> <li>Loading <b>M3</b> payload</li> <li>Deploying, remotely, all the packages one at a time</li> </ul>	$\frac{Min\_time}{N\_time}$	

#### 3.2 Score Sensitivity Analysis

Mission and scoring analysis showed that, apart from the report score, the overall score is affected by two major independent design parameters: the number of syringes and the number of vaccine vial packages. Other parameters that affect the score are function of these two parameters. To accurately model the impact of varying the parameters on the score, the team carried out two sensitivity analyses: non-linear (direct re-evaluation based) and linear (Taylor series expansion based) analyses.

In the non-linear analysis, using a “MATLAB” code, each parameter was varied while keeping the other parameters as constants at their nominal values. Some physical parameters in the mathematical model were estimated based on the team's experience. A safety factor was added to account for the estimation errors and Wichita's wind speed uncertainty. In calculating the score, an expectation was made for the top team's performance that falls within the limits of the rules' design and mission constraints. **10,000** payload combinations' scores were evaluated and fitted into the surface plotted in *figure 3.1*, to visualize the score field. To get a sense of the individual parameter variation impact, the score percent change was calculated and plotted in *figure 3.2*.

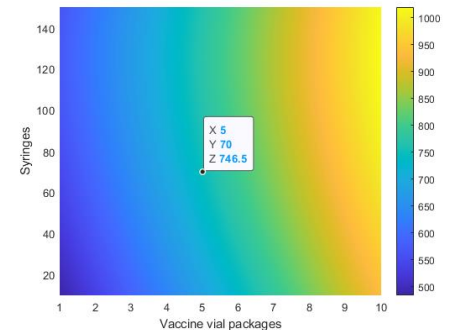

Figure 3.1: Score Estimation vs Mission Payload

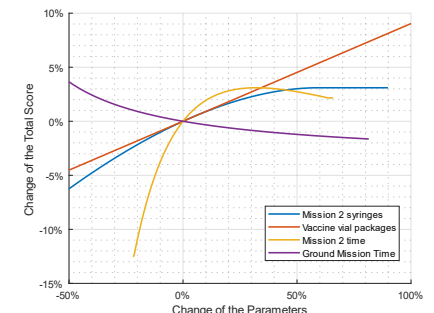

Figure 3.2: Score Variation with Parameters

As a validation of the evaluated percent change, the fractional sensitivities of the individual parameters, shown in *table 3.2*, were calculated at the nominal value, using the partial differentiation solver in “Wolfram Mathematica”. As shown, both approaches confirmed that there is no conflict between maximizing both payloads with a much higher score sensitivity to the number of packages. In addition, the analysis showed that the impact of decreasing **M2** time within the propulsion limits has a negative impact as it corresponds to decreasing the number of syringes drastically. Hence, superiority was given to maximizing **M2** payload over minimizing the lap time. Furthermore, the ground mission time is neither an explicit function of the payload nor the aircraft performance, nor was it directly constrained by the rules. The score, however, is highly sensitive to its variation. Hence, the analysis output directs the team to minimize the loading/unloading time by increasing the payload accessibility. In conclusion, it was decided to focus on maximizing **M3** payload– which insets the minimum **M2** payload– with the **100 Watt-hr** energy constraint, the expected lap time as well as the structural and propulsion capabilities of the team taken into consideration.

Table 3.2: Fractional Sensitivities @ nominal value

$\frac{Report}{Score} \frac{\partial Score}{\partial Report}$	1
$\frac{T_{GM}}{Score} \frac{\partial Score}{\partial T_{GM}}$	-0.07426
$\frac{Syringes}{Score} \frac{\partial Score}{\partial Syringe}$	0.00522
$\frac{Packages}{Score} \frac{\partial Score}{\partial Package}$	0.04678

Based on that, the design point, illustrated in *figure 3.1*, was chosen for the first prototype iteration. The sensitivity analysis results guide the optimization cycles of the upcoming prototypes towards minimizing the overall lap time in order to maximize the number of packages in *M3*.

### 3.3 Preliminary Design

Based on the subsystem requirements and the sensitivity analysis results, a conventional, high rectangular wing with a conventional empennage A/C was chosen for its simplicity, high storage capacity, stability, and control.

This configuration guides the input set to the *UDC Aircraft Sizer*– a MATLAB framework designed by the team. The main advantage of this code is in automating– using a design input set– the A/C sizing, stability testing, and performance modeling, which speeds up the preliminary decision-making phase. *Figure 3.3* illustrates the code’s algorithm, which is based on the classical design approach (Roskam’s methodology).

The code inputs start with the desired performance parameters (maximum  $V_{stall}$ , minimum  $V_{max}$ , maximum takeoff distance, etc.) to constrain the design region. Using the wing loading and an initial MTOW estimation, the subsystem sizing begins with the wing sizing, after which the code iterates on the empennage sizing, utilizing AVL software, till a stable combination is achieved. Afterward, the drag and the power required are calculated, and the output is fed back to the propulsion sizing function. Based on that, the motor, ESC, and the propeller of each mission are selected. The MTOW is calculated again and compared to the initial guess to start a new iteration with the new MTOW if needed. Finally, the mission model estimates the lap time, the number of laps, and the expected score for each mission. It’s worth noting that the initial MTOW estimation is done using an empirical equation that relates the MTOW to the payload and the manufacturing technique (foam core composite, balsa build-up, etc.). The equation is formulated by curve fitting a database collected by the team members from previous AIAA DBF design reports.

Several code runs, satisfying the mission’s low Reynolds number range, were made to reach the optimum preliminary design, shown in *figure 3.4*. The A/C has a MTOW of **12.5 lb**, and cruises in *M2* and *M3* at **131.23 ft/s** and **72.2 ft/s**, respectively. The wing airfoil is “*SD7090*” with a planform area of **6.56 ft<sup>2</sup>** and an aspect ratio of 5. This aircraft can takeoff in **19.7 ft** only, due to its small stall speed (**32.8 ft/s**). In *M2*, the aircraft carries **70** syringes and finishes the mission in **1.34 min**, and in *M3*, the aircraft can drop five vaccine vial packages in the 10-min flight window.

Furthermore, the dropping mechanism and the steering system design are critical for *M3*; hence, thorough analysis and design efforts are directed towards them. To ensure a smooth deployment of the package without tripping the **5g** shock sensor, the mechanism shown in *figure 3.5*, was chosen due to its simplicity. The package will slide out of the A/C rear, under its own weight, on a door to the ground. To achieve this, the landing gear was sized to give the aircraft a high inclination angle with low ground clearance. Further analysis of the deploying door friction coefficient is progressing to decelerate the box descend and lower the impact. Moreover, servo motor stations are installed on the fuselage wall to prevent the boxes from moving during flight and ensure dropping one package at a time. Furthermore, a spring system will be employed to dampen the multiple landings impact on the steering system fixation.

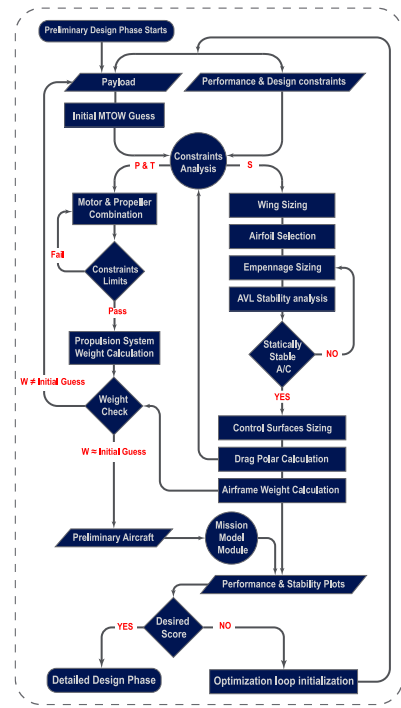

Figure 3.3: Code Algorithm Flow Chart

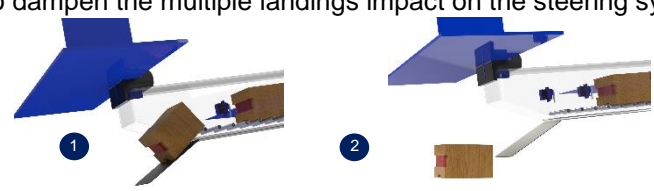

Figure 3.5: Mechanism Working Illustration

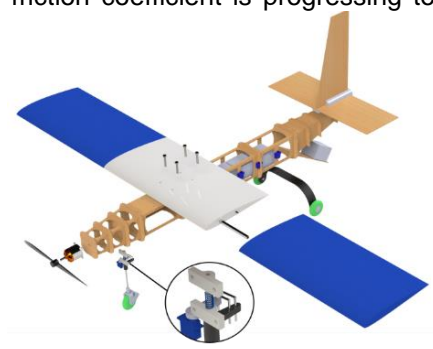

Figure 3.4: Preliminary A/C CAD Model

## 4.0 Manufacturing Plan

Figure 4.1 illustrates the preliminary manufacturing flow. The manufacturing plan consists of several stages distributed throughout the pre-assigned interval for manufacturing. As shown in Figure 2.2, the interval assigned for manufacturing overlaps with the testing interval, as it is constructed to be an iterative process in which parts will be replaced if destructively tested, or the design itself will be refined for the upcoming prototype using the dataset collected from tests.

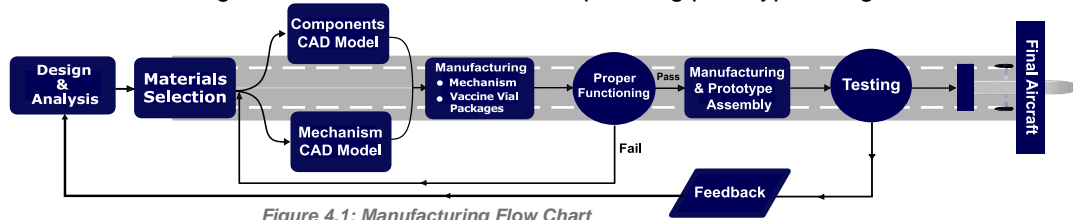

Figure 4.1: Manufacturing Flow Chart

The materials selection is based on the design chosen, the materials and technologies accessible at the UDC lab, and SolidWorks structural simulation that predicts the stress levels of the critical elements under design loads.

Preliminary results and studies suggested using balsa wood for the first prototype to make the fuselage streamlined shape easier to manufacture while retaining structural integrity and covering it with MonoKote to achieve a smoother surface finish to reduce the drag on the aircraft. In addition, the wing will be manufactured using the foam-core composite technique to withstand the applied loads. To maintain a lightweight structure, the motor mount will be manufactured using plywood. Due to their complexity, the motor mount reinforcing parts and the steering system will be 3D-printed. The main landing gear will be manufactured from carbon fiber. Moreover, the nose landing gear will be made of an aluminum rod integrated with a damping system to absorb the energy of the landing impact and thereby reduce the loads delivered to the airframe. All the wooden parts will be cut using the CNC laser cutter. In addition, any other complex joints will be 3D-printed.

Since the aircraft must be flown with the deployment mechanism for all three missions, the mechanism is designed to be screwed to the fuselage. A roller conveyor mechanism design is implemented in the package dropping. The rollers are smooth aluminum tubes for the vaccine vial packages to slide easily towards the door. The aluminum rollers will rotate around aluminum rods that are fixed to the fuselage sidewalls via bolts.

## 5.0 Testing Plan

The team's testing plan consists of two phases: pre-assembly phase, in which the aircraft subsystems will be tested separately before being integrated into the aircraft, and post-assembly phase, in which the aircraft will be tested in the flight configuration. Tests will be conducted to validate the aircraft's, analytically, estimated behavior and verify that the prototype meets the design requirements. Further testing will be carried out to observe and analyze the aircraft performance under conditions that mimic this year's missions and accordingly use the real-time data collected and the pilot's feedback to refine the upcoming prototypes. Table 5.1 demonstrates the description, main objectives, and the deadline for each test.

Table 5.1: Testing schedule and tests' description and objective

	Test	Description	Objective	Prototype Deadline	
				1st	2nd
Prop.	Batteries & Fuse	The system will be fixed to a thrust bench during operation while monitoring its states, the batteries will be fully discharged, and the motor will be tested at different throttles	Determination of the batteries' voltage, discharge rate, and the drawn current	21 Oct.	21 Dec.
	Static Thrust		Testing the motor efficiency and the static thrust	21 Oct.	21 Dec.
	Dynamic Thrust	The system will be tested in the wind tunnel at different speed conditions	Dynamic thrust calculations and propeller & motor efficiency analysis	21 Oct.	21 Dec.
Structure	Motor Mount	Thrust-equivalent weights will be vertically attached to the nose of the aircraft	Ensure that the airframe can withstand the thrust generated by the propeller	1 Nov.	14 Jan.
	Wing Tip	The fully loaded aircraft will be lifted by the wingtips	Ensure that the wing structure can carry the full load without plastic deformation	7 Nov.	14 Jan.
	Landing Gear	The fully loaded aircraft will be dropped on the landing gear from a 2-foot height	Ensure its endurance to the impacting load	7 Nov.	14 Jan.
	Steering System	A taxing test	Testing the system functionality and the steering controllability in multiple scenarios	14 Nov.	14 Jan.
Aerodynamics	Dropping Mechanism	The vaccine vial packages will be deployed one at a time on the ground	Ensure the reliability of the mechanism and its ability to deploy all the packages safely	14 Nov.	14 Jan.
	Gliding	A preliminary prototype with the same CG will be hand-launched and observed	Testing the aircraft's stability and modifying the aircraft's CG accordingly	21 Oct.	21 Dec.
	Wind Tunnel	A scaled prototype will be tested in the wind tunnel	Measuring the aircraft's aerodynamics coefficients	21 Oct.	21 Dec.
	Flight Test #1	A prototype of the designed aircraft, with no payload, will be flown and observed	Testing the aircraft characteristics like controllability, response, stability, and ability to complete the flight course	21 Nov.	21 Jan.
	Flight Test #2	The A/C with the maximum number of syringes installed will be flown and observed	Simulating the second flight mission and analyzing the performance of the loaded A/C	30 Nov.	20 Feb.
	Flight Test #3	The aircraft with the maximum number of vaccine vial packages and the deploying mechanism installed will be flown and observed	Simulating the third flight mission and testing the aircraft characteristics, like controllability, response, stability, and ability to complete the flight course	30 Nov.	20 Feb.
	GM Simulation	A timed mission simulation of the actual ground mission	Performing the ground mission in the minimum possible time	30 Nov.	20 Feb.



# The Hong Kong Polytechnic University

## 2021-22 Design/Build/Fly Team – AEOLUS Proposal

### 1. Executive Summary

This proposal outlines The Hong Kong Polytechnic University's (PolyU) AIAA DBF team AEOLUS' design approach, manufacturing and testing plan for entry of the 2022 DBF competition.

The competition objective this year is to complete a series of Humanitarian Missions by designing and manufacturing an unmanned, electric-powered, radio-controlled aircraft for vaccine transportation and delivery. The aircraft must be capable to carry a maximized number of 30 ml syringes to simulate transportation of vaccination syringes. Moreover, it must also be able to perform multiple successful smooth landings and deploy vaccine vial packages containing three shock-sensors in the vertical, lateral, and longitudinal orientation to simulate fragile vaccine multi-destination delivery. The aircraft must not exceed a linear dimension of 8 feet and be able to take-off within 25 feet for all three missions.

The subsequent sections summarised AEOLUS's organisational structure, conceptual design approach and manufacturing plan. In order to achieve a maximum score, our team conducted a sensitivity analysis to determine the best aircraft configuration and design parameters. The results of the analysis indicated the optimal number of payloads for maximum mission scoring, which is included as a criterion in the preliminary design process. After comparing various aircraft configurations by a scoring system, we came up with a conceptual design of an aircraft having a high wing, conventional tail, single-puller motor, and tricycle landing gear which will carry 36 syringes and 3 vaccine vial packages. The vaccine vials will be deployed using a track-and-rail system with a cargo door opening and servo lock control.

### 2. Management Summary

#### a. Organization

Sub-Team	Roles	Skills
Faculty Advisor	- Monitor team's performance and assist in departmental administrative work	- Expertise in aviation and UAV field - Possession of power to supervise the team
Team Leader	- Allocate tasks and monitor the teams' working progress - Determine teams' workflow and ensure quality of work	- Possession of good communication and leadership skills - Thorough understanding and macro vision of the competition
Aerodynamics	- Compute and determine the appropriate sizing and shape of aerodynamic surfaces - Conduct aerodynamic simulations and analyses to ensure aircraft stability and efficiency	- Knowledge of aerodynamics, aircraft stability and analytic calculations - Proficiency in aerodynamic simulation & analysis software
Structure	- Design overall aircraft structure, e.g., wing, tail, fuselage, landing gear etc. - Conduct structural analysis to ensure aircraft structural strength - Select proper materials and manufacture aircraft prototypes - Perform testing on aircraft components	- Knowledge of different aircraft structures and material properties - Knowledge of different non-destructive testing methods - Proficiency in CAD and structural analysis software - Possession of delicate craftsmanship and manufacturing skills of different materials
Aircraft System	- Conduct Sensitivity Analysis - Integrate internal systems such as electrical powering, wiring and telemetry for data logging - Ensure the reliability of power system in aircraft manufacturing phase	- Knowledge of avionics and electrical power system - Proficiency in MATLAB and telemetry-related software - Possession of good soldering skills
General	- Handle general administrative work like budgeting, sponsorships and documentations - Assist other teammates in aircraft manufacturing	- Experience in secretary work and good organization skills - Proficiency in design and photo editing software

Table 2 – a

Our team - AEOLUS consists of 3 faculty advisors, 9 final-year senior students and 5 non-final-year students. The project is purely student-led with occasional consultations with faculty advisors for progress monitoring and design review. Faculty advisors mainly provide guidance and help with departmental administration work. Two Team Leaders which are elected by team members act as the bridge to connect different sub teams, allowing them to cooperate well together. Having two Team Leaders favours better decision-making process under harmonious cooperation. Despite consultation, Team Leaders

hold weekly internal meeting for task allocation and discussion on major decisions. The rest of the team members are divided into four sub-teams according to their skills and preferences. Each sub team is led by a PIC (Person In Charge) who is responsible for communicating with Team Leaders and PICs of other sub- teams to keep team members tracked and updated. A Pilot will be elected and trained to control our final competition aircraft. Table 2–a described all the roles and skills required for every party.

**b. Organisation Chart**

Figure 2-b depicts the structure of the team. While all teams are responsible in their specific related field, teams are also encouraged to work together as a whole to assist each other when necessary. Despite the hierarchical form, our team appreciates and accepts every member’s opinion and suggestion. We treat each member with respect and equality throughout work.

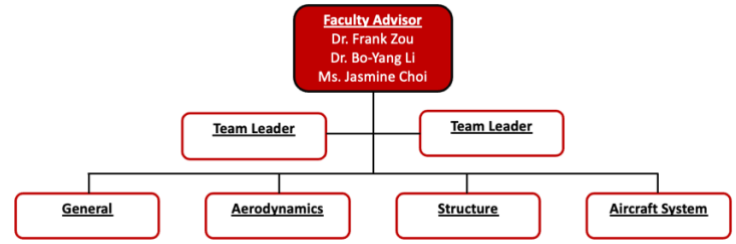

Figure 2 – b

**c. Schedule**

The following Gantt chart shows our schedule from Summer 2021 to April 2022. Our team will audit it weekly to maintain a satisfactory progress throughout the whole period. During the Summer, we gained valuable experience by manufacturing an aircraft according to

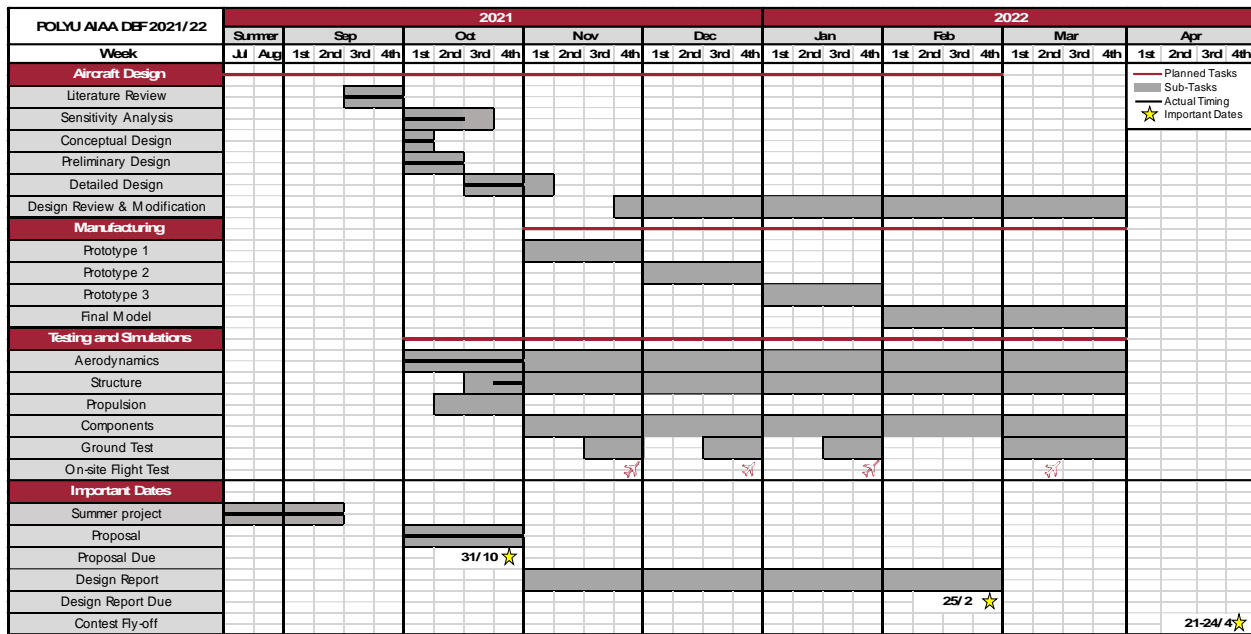

Figure 2 – c

the rules of DBF 2021 which instilled technical expertise and time-management skills in us and allowed us to prepare for the upcoming competition.

**d. Budget**

Funding for our team comes from three primary sources: PolyU - Department of Aeronautical and Aviation Engineering (AAE), Faculty of Engineering (FENG) and Global Engagement Office (GEO). Additionally, Milwaukee Tool Hong Kong is sponsoring us with hand tools and equipment for manufacturing. We expect to obtain \$3,000 from AAE, \$4,000 from FENG and \$13,000 from GEO.

2021/22 Project Budget Plan			
Category	Item	Cost (USD)	Total (USD)
Materials	Motor, Propeller, Battery, ESC	400	1,200
	Transmitter, Receiver, Servos, Wires	500	
	Landing gear, Wheels, Mission-related components	300	
Manufacturing	Carbon Rod & strips, foam, plastic film	300	700
	Balsa, Paulownia, Plywood	300	
	3D printing	100	
Travel	Visa & Air ticket (10 members)	11,600	17,900
	Lodging and Meals (10 members, 6 nights)	6,000	
	Local shipping/ transportation	300	
			<b>\$19,800.0</b>

Table 2 – d

### 3. Conceptual Design Approach

#### a. Mission Requirement

The competition objective is to design a multifunctional aircraft that can carry syringes and deploy vaccine vial packages without triggering the three 5G shock sensors attached on each package. Maximum aircraft linear dimension is 8 feet. Take off field length (TOFL) is 25 feet in all missions. Table 3–a summarizes all mission requirements.

Mission	Mission Requirements	Sub-system Requirements
<b>Mission 1</b>	- Empty payload - 5-minute flight window for completing 3 laps	- Ensure the aircraft is light enough to perform a short field length take off
<b>Mission 2</b>	- Carry at least 10 syringes - Carry as many syringes as possible to maximize the score - Flight window, no. of laps are same as M1	- Scoring is dependent upon flight speed and payload capacity - A customizable system to suit both missions while keeping it light weight
<b>Mission 3</b>	- No. of vaccine vial packages ≤ (No. of syringes in M2) /10, round down to nearest whole number - Successfully land and deploy the vaccine vial packages in the drop area (one per lap) without tripping the shock sensor - 10 minutes flight window	- Maintain the CG in margin after the deployment of packages - Design a light and easy-to-use mechanism for mission 3
<b>Ground Mission</b>	- Load and remove mission 2 and 3 payloads - Remotely deploy mission 3 payloads	- Simplify cargo loading method - Test different deploy mechanisms to avoiding triggering the shock sensors

Table 3 – a

#### b. Sensitivity Analysis

Sensitivity Analysis aims to discover the relationship between design parameters and mission score, and to figure out the maximum score that is realistic for our team. The desired design parameters which directly affect the mission scores are listed out in Table 3-b. The scoring from Mission 1 does not have much effect on design parameters and is not included as we assumed that we will complete it successfully to get the score. It is evident from the scoring equations that the mission score increases with the amount of payload that the aircraft can carry. To determine the optimum amount of payload for maximizing mission score, our team developed a MATLAB® Code based on AEOLUS's past experience, which compares the effect of numerous aircraft configurations on the total mission score. We not only have different constraints built according to competition rules and aircraft performances restrictions such as battery energy limit, take-off field length and motor power limit, but also other feasibility limitations such as average taxiing and ground deployment time for each lap of Mission 3. The results of the analysis are shown in Figure 3-b. It indicates that the optimal mission score can be achieved by carrying 60 syringes and 3 vaccine vials. However, the final decision has to be compromised with actual feasibility and performance. Constraints such as rule regarding consistent aircraft configuration, ease of cargo loading and vaccine vial deployment mechanism design affect the overall mission score in a non-quantitative way. In addition, we believe that a reduction of payload will result in a proportional increase of Ground Mission score as it decreases the time for cargo loading to a certain extent. Therefore, after thorough consideration we decide to carry 36 syringes and 3 vaccine vials after balancing pros and cons of various aspects. The payload storage mechanism is illustrated in detail in the following section.

Design Parameters	Mission Scoring	Feasibility limitations
Number of Syringes	$M2 = 1 + \frac{N_{\text{(#syringes/time)}}}{\text{Max}_{\text{(#syringes/time)}}$	- Fuselage size due to 'same aircraft configuration for all mission' requirement
Number of Vaccine Vials	$M3 = 2 + \frac{N_{\text{(#successful_deployments)}}}{\text{Max}_{\text{(#successful_deployments)}}$	- Ground deployment time in Mission 3
\	$GM = \frac{\text{Min}_{\text{time}}}{N_{\text{time}}}$	- Ease of cargo Loading

Table 3 – b

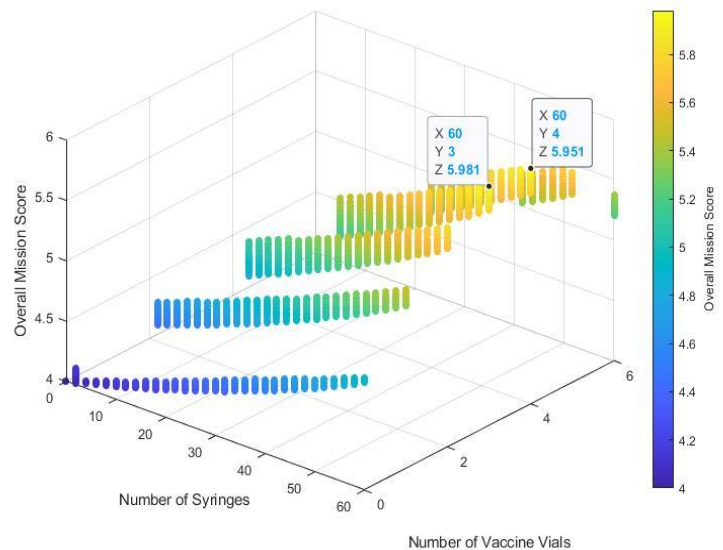

Figure 3 – b



### c. Preliminary Design

The primary focus was to minimize the empty weight of the aircraft to ensure a take-off within 25 ft. Results of the sensitivity analysis showed that the maximum take-off weight of our aircraft will be 13.9 lb. The conceptual design of our first prototype is shown in the Figure 3-c.1. After analysing various airfoils, we selected MH-114 airfoil as it provided minimal drag under the range of estimated cruising  $C_L$  obtained from sensitivity analysis for all three missions. The constraint analysis was used to determine the optimal wing loading ( $W/S$ ) and thrust to weight ratio ( $T/W$ ). The cruise airspeed, take-off velocity, rate of climb, and level constant-velocity turn were calculated as a function of  $W/S$ . Results showed that the optimal wing loading is approximately  $2.3 \text{ lb}\cdot\text{ft}^{-2}$  and the wing area can then be calculated to be  $6.171 \text{ ft}^2$  with an aspect ratio of 8 to maximize wing efficiency. The sizing on the tail was mainly based on the desired static margin of 17% to ensure proper stability of the aircraft and to provide enough margin for CG shift during M3. The dimensions of the aircraft surfaces are shown in table 3 – c. Subsequently, analysis was performed on the aerodynamic surfaces using XFLR5 to ensure adequate lift forces are generated for a 25 ft take-off. Both the horizontal and vertical stabilizer will use the NACA0012 airfoil.



Figure 3 – c.1

	Wing	Horizontal Tail	Vertical Tail
Mean Chord (ft)	0.879	0.517	0.728
Span (ft)	7.03	2.068	0.984
Planform Area	6.171	1.069	0.713
Aspect Ratio ( $\text{ft}^2$ )	8	4	1.36
Volume Ratio	-	0.6	0.05

Table 3 – c

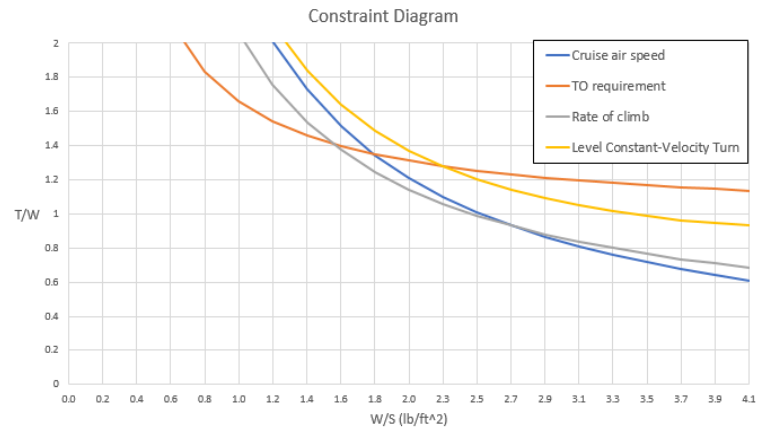

Figure 3 – c.2

To maintain the same aircraft configuration for all 3 missions, our team designed a universal container that can carry all types of payloads. Each cart can either carry 12 syringes in M2 or one vaccine vial package in M3. In order to minimize fuselage weight to ensure successful T/O within the TOFL, we decided to compromise on the number of syringes to be carried on board. The space and size of each universal container is another limiting factor that restrict us from carrying more than 36 syringes. Three carts are connected in series and positioned on top of a rail track with servo locks between the carts as shown in Figure 3-c.5. Servos are settled in the gap underneath the carts, between the rails. During cruising stage, the servo arm is in vertical position which locks the L hooks of two carts together and avoids slipping as demonstrated in Figure 3-c.4. Once the aircraft is landed and reaches the designated drop zone, the cargo door which houses the rail track will be lowered to the ground by the rod-extension system using two servos. After the cargo door is lowered, the servo arm will be triggered and rotated by transmitter control manually so that the L-lock between two carts will be disengaged. The first cart is free to slide down the rail track to the deployment area due to the natural downward slope created by the cargo door. Servo arm will remain triggered at the same position after deployment so there will not be any obstruction on the track for the upcoming cart deployment.



Figure 3 – c.3

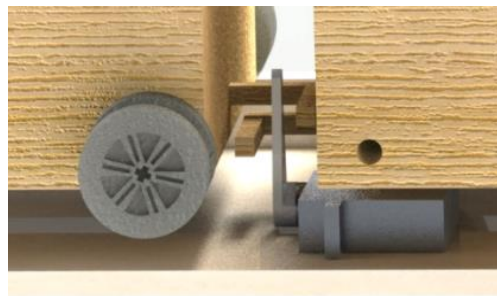

Figure 3-c.4

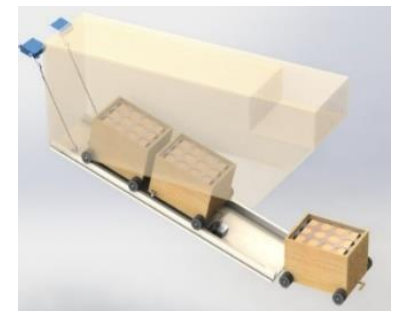

Figure 3 – c.5

#### 4. Manufacturing Plan

##### a. Preliminary Manufacturing Flow

From preliminary design to detail design of components, aircraft shape and material will be determined. Referring to the Gantt chart (Figure 2-C), the manufacturing cycle will span over four weeks for each prototype. Unless the fundamental design concept changes, only slight modifications to the design should be made. Figure 4-a shows the detail flow of each manufacturing cycle.

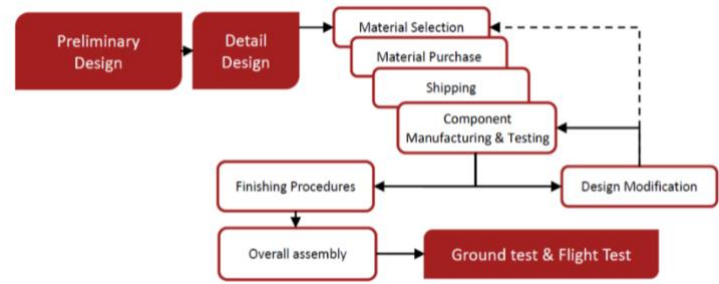

Figure 4 – a

##### b. Critical Process and Technologies required

Wood will be the major material used in the aircraft, including balsa, paulownia and plywood. To ease manufacturing and ensure precision, wooden parts will be cut by CNC laser cutting. Specific assembly jigs could be fabricated and used to minimize human error during assembly. 3D-printed parts (PLA) will also be used, to accurately achieve complex shapes. These parts will be designed using CAD software and produced with 3D-printers, with minimal post processing. However, due to production, 3D-printed parts shall only be used sparingly. Composite materials will be considered for large components requiring high strength, such as the landing gear and tail boom. After-market composite products are considered, but parts with specific requirements will be produced in-house with resin mould or PLA printed moulds. Once all structural components of the airframe of each prototype is completed, the airframe will be wrapped in heat-adhesive RC aircraft skin to achieve the aerodynamic shape of the aircraft.

#### 5. Test Planning

##### a. Component and Ground Test Plan

Category	Test	Purpose	Method
Aerodynamics	Stability analysis	Ensure static and dynamic stability longitudinally and laterally	Retrieve $C_m$ from Trefftz's Plot, stability derivatives from stability analysis chart, and eigen values from root locus graph using AVL
	Aerodynamic efficiency	Optimise lift efficiency of aerodynamic surfaces	Use FLUENT (FVM) to calculate realistic values of $C_L$ , $C_D$ , $C_M$ and $C_p$
Structure	Structural integrity	Ensure aircraft structures can withstand the loading during operation	Use ANSYS (FEA) to apply expected normal and shear forces
	Wing tip loading test	Confirm the structural reliability and strength of the wing under high loadings	Place a heavy mass on the wingtip to simulate a $\pm 5g$ loading
Propulsion	Thrust test	Choose appropriate motor-propeller combination that provides the desired thrust-to-weight ratio	Perform static thrust test on different propulsion systems. Record the measured thrust, battery current and voltage
Components	Landing gear test	Evaluate strength of the landing gear mounted under the wing	Conduct drop test from various heights within margins
	Deployment mechanism and shock test	Establish a suitable travelling speed of the cart to ensure the shock sensors do not trigger and the cart stops within the drop-off zone	Calculate the travelling speed of the cart and check shock sensors' condition. Modify the surfaces of wheels and sliding track iteratively to create the right amount of friction.
Ground	Taxi test	Ensure satisfactory ground maneuverability while taxiing	Manoeuvre the aircraft to taxi in all directions including sharp U-turns
	Control surfaces	Ensure all of them are working properly within our designed deflection angles	Use transmitter for testing
	CG test	Ensure that the CG is at the desired location	Lift the aircraft from the marked points at each wing and see if it levels out
	Loading and unloading	Minimize the time used in performing ground mission	Time each ground mission trial using stopwatch. Practise more and familiarise with the loading and unloading process

Table 5 – a

All the components and mission mechanism will be tested to verify their functionality and reliability. Tests will be done according to the schedule stated in the Gantt chart (Figure 2-c).

##### b. Flight Test Plan

After manufacturing each prototype, an on-site flight test will be carried out for the aircraft to carry out all three missions according to the competition flight course. Pixhawk mini 4 will be used to record data inflight and perform failsafe function when necessary. Collected data such as T/O distance, speed, range, battery endurance etc. will be plotted on graphs for performance analysis. Apart from numerical data, pilot's feedback is also vital in reflecting flight performance. Various combinations of wing configuration, payload weight, and motor-propeller will be tested to optimize mission score. Each prototype will undergo design iterations until an optimum performance is obtained in the final model.



# 2021-2022 AIAA Design, Build, Fly Proposal Virginia Tech



## 1. EXECUTIVE SUMMARY

This proposal provides detailed information regarding Virginia Tech’s plan for design, testing, manufacturing, and analysis for the 2021-2022 AIAA Design Build Fly competition. The overall objective is to develop a cargo aircraft capable of delivering environmentally sensitive medical supplies such as syringes and vaccine vial packages (VVPs). The aircraft must have a maximum linear dimension of 8 feet and a ground-rolling takeoff distance of 25 ft.

The team performed scoring and sensitivity analysis to better understand critical aspects of the mission and effectively maximize the competition score. This analysis indicated that maximizing speed was the most important factor. The aircraft will have a monoplane configuration with a dual motor propulsion system, tricycle gear, conventional tail, and a fuselage capable of carrying 6 VVPs and 70 syringes. The aircraft will have an 8 ft wingspan, a maximum speed of 117 ft/s, and shock mitigation systems that can safely and reliably deploy the VVPs. These systems include utilizing shock absorbers with the aircraft’s landing gear and using internal dampening within the fuselage.

## 2. MANAGEMENT SUMMARY

### 2.1. Team Organization

The 2021-2022 Design Build Fly at Virginia Tech team (VT DBF) is entirely student led and consists of 13 leads and 2 pilots, primarily composed of juniors and seniors. The team has 35 additional underclassmen members and a faculty sponsor from the Aerospace Engineering department. As seen in *Figure 1*, the team leaders (**dark orange**) consist of the Chief Engineer, responsible for key technical decisions and overall systems and component integration on the aircraft, and the Project Manager, responsible for team administration including maintaining the schedule and handling finances.

The remainder of the team is divided into seven distinct sub-teams led by one or two sub-team leads (**orange**). The Aerodynamics team sizes the wing and analyzes aircraft performance. The Electronics and Propulsion team decides on the aircraft’s propeller, motor, battery, and ESC through static and dynamic thrust tests. The Stability and Controls team sizes the tail and control surfaces to ensure stable flight and maneuverability. The Structures team designs the internal structure of the plane and conducts Finite Element Analysis (FEA) to guarantee overall structural integrity during flight. The Systems team creates an efficient and safe mechanism to deploy the VVPs. The CAD team produces digital models to be sent to the Manufacturing team who determines proper build methods to produce each aircraft. The team also has a representative for the Virginia Tech Student Engineer’s Council (SEC) to acquire university funding.

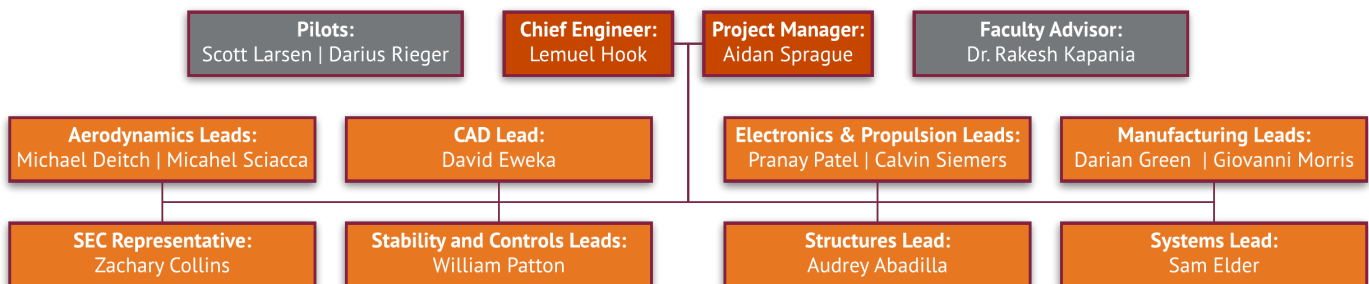

Figure 1: VT DBF 2021-2022 Team Organization





## 2.2. Project Schedule

To ensure that all project deadlines are met, a Gantt chart shown in *Figure 2* is utilized to keep sub-teams on track.

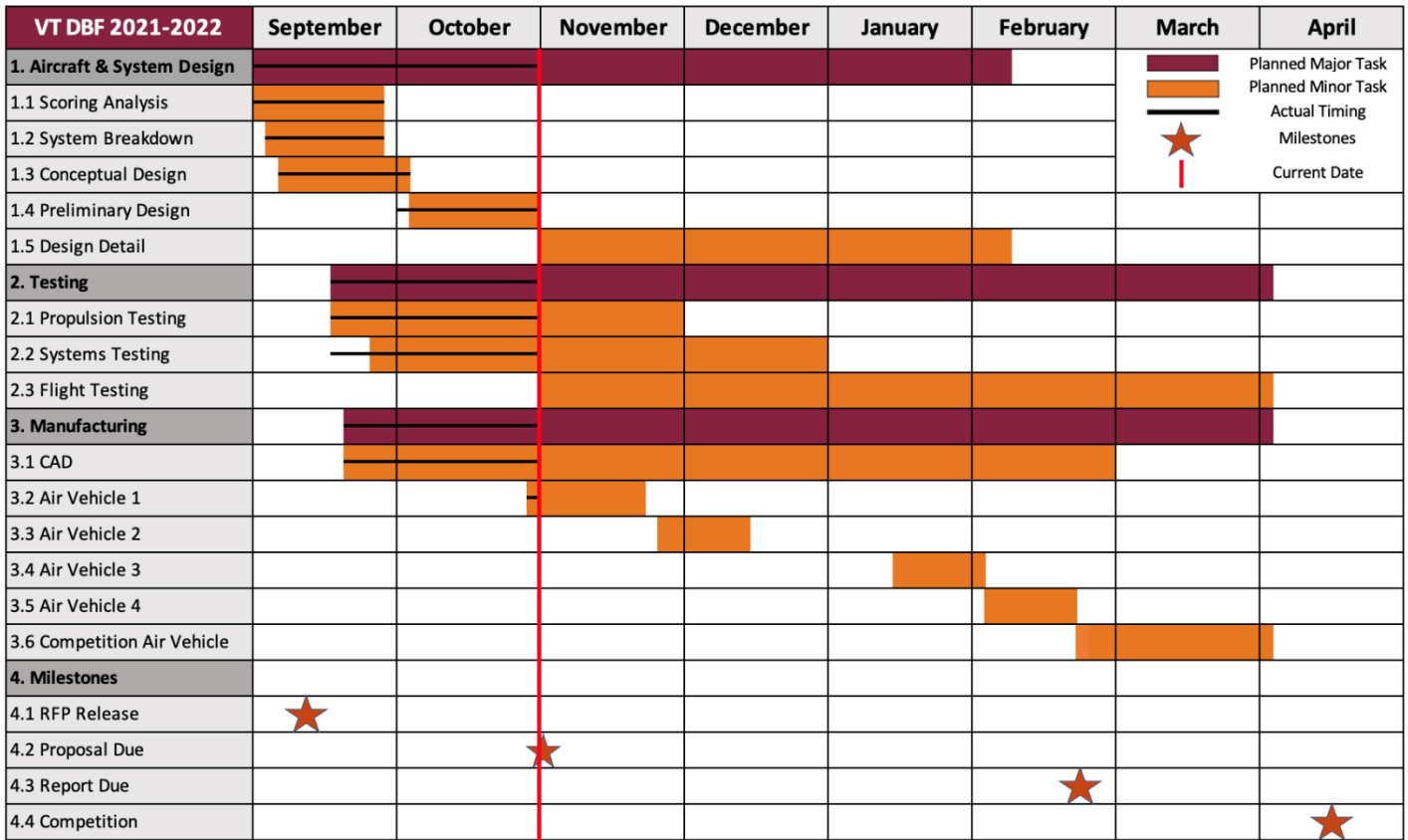

Figure 2: VT DBF 2021-2022 Gantt Chart

## 2.3. Project Budget

For the 2021-2022 competition year, the team has budgeted \$25,250 as displayed in *Table 1*. Primary expenditures are split into three main categories: electronics / propulsion, manufacturing, and travel. Over half of the team budget is allocated towards traveling to allow all team leads and several members to attend competition. The team receives funding primarily through the university via the Aerospace Engineering department, Student Engineer's Council, and Student Budget Board. To supplement this, additional funds are received through corporate sponsorships, alumni donations, and crowdfunding.

	Item	Cost (USD)
Electronics / Propulsion	Brushless Motors	\$400.00
	ESCs	\$150.00
	Batteries	\$500.00
	Props & Hardware	\$300.00
	Servos & Hardware	\$250.00
	Transmitters & Receivers	\$350.00
Manufacturing	Carbon Fiber	\$2,000.00
	Composite Material	\$1,500.00
	Balsa Wood	\$1,500.00
	Bass Wood	\$500.00
	CA, Epoxy, Adhesives	\$500.00
	MonoKote	\$300.00
	Foam	\$250.00
	Landing Gear	\$500.00
	Shock Sensors & Syringes	\$500.00
	Misc. Hardware	\$750.00
Travel	Transportation	\$3,000.00
	Aircraft Packaging	\$1,000.00
	Hotels & Lodging	\$6,000.00
	Meals	\$5,000.00
	Total:	<b>\$25,250.00</b>

Table 1: 2021-2022 Budget

## 3. CONCEPTUAL DESIGN APPROACH

### 3.1. Mission Requirements

This year's competition entails the design of a remote controlled Unmanned Aerial System (UAS) capable of transporting and deploying syringes and vaccine vial packages without exceeding 5G loads. The competition aircraft must complete one





ground mission and three flying missions, each requiring a maximum takeoff distance of 25 ft and a successful landing.

Table 2 briefly describes the requirements for each mission, corresponding design objective, and scoring equation.

Mission	Mission Requirements	Design Objectives	Score
GM	<ul style="list-style-type: none"> <li>Load and unload syringes</li> <li>Load vaccine vial packages</li> <li>Remote deployment of entire M3 payload</li> </ul>	<ul style="list-style-type: none"> <li>Design for efficient installation/retrieval of each payload</li> <li>Manufacture quick, reliable shock mitigating deployment mechanism with low complexity</li> </ul>	$GM = \frac{t_{min}}{t}$
Flight Missions	M1	<ul style="list-style-type: none"> <li>Design wing and propulsion systems to ensure 25-foot takeoff</li> <li>Size tail to counteract large shifts of CG placement and moments during takeoff and landing</li> <li>Maximize cruise speed to increase VVP deployment and reduce lap times</li> <li>Effective shock mitigation systems for flight, landing/takeoff, and deployment</li> <li>Maximizing fuselage volume to allow for maximum syringe and VVP capacity</li> </ul>	$M1 = 1$
	M2		$M2 = 1 + \frac{s}{\left(\frac{s}{t}\right)_{max}}$
	M3		$M3 = 2 + \frac{d}{d_{max}}$

Table 2: Mission Requirements, Design Objectives, and Scores

### 3.2. Scoring Analysis and Sensitivity

To determine which mission aspects and aircraft features have the highest effect on the score, the team developed a MATLAB script that generates sensitivity plots using the provided mission equations. M2 and M3 were directly compared to determine which had a greater effect on the overall score of the competition as well as what scoring factor had the greatest effect on the score of each mission. Figure 3 shows that M2 and M3 have equivalent effects on the overall score of the competition while the report is more important.

As seen in Figure 4, an incremental improvement in the number of syringes yields a linearly proportional increase in the score for M2.

Conversely, an incremental improvement in lap time in M2 (shown here as decreasing the mission parameter) yields a nonlinear return in score, which improves the more it is decreased. This pattern is shown as well for M3 and is highlighted in Figure 5, where the number of VVP deployments was related to lap time. These results led the team to conclude that speed is the most important factor in the design of this aircraft as it plays a key role in the number of VVP deployments in M3 and lap time in M2.

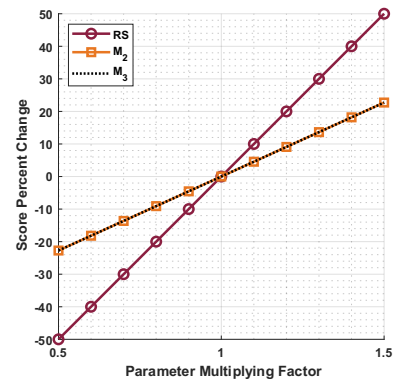

Figure 3: Total Score Analysis

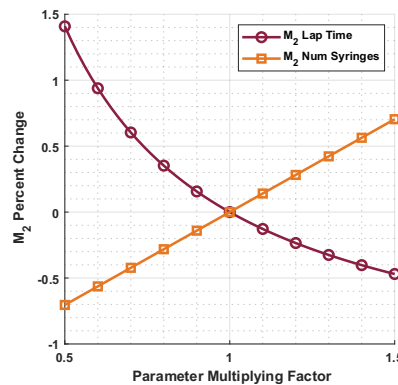

Figure 4: M2 Sensitivity Analysis

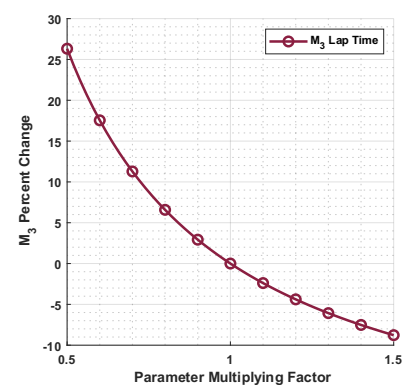

Figure 5: M3 Sensitivity Analysis

### 3.3. Preliminary Design

The following configurations and sizes were selected to maximize speed as the sensitivity analysis highlighted. A conventional high wing aircraft configuration was selected for its manufacturability and drag characteristics. The wing includes a rectangular shape with a span of 8 ft, chord of 1 ft, and contains the NACA 2412 as its airfoil. A variety of airfoils and wings were analyzed using XFLR5 and Athena Vortex Lattice (AVL), and the NACA 2412 produced the least



amount of drag during cruise. To achieve the required takeoff distance of 25 ft, plain flaps are utilized. These flaps occupy 78% of the wingspan, extend to 40% of the wing chord, and have a maximum deflection of 30 degrees. This gives the aircraft a maximum takeoff weight of approximately 21 lbs.

A conventional aft tail configuration with rectangular stabilizers was selected for the empennage design due to simplicity for manufacturing and design. From historical RC aircraft data, the horizontal and vertical stabilizer volume coefficients were selected to be 0.5 and 0.08, respectively. A tail arm of 3.58 ft was selected to minimize aircraft drag. This yielded a horizontal stabilizer area of 1.12 ft<sup>2</sup> and a vertical stabilizer area of 1.43 ft<sup>2</sup>. This design resulted in a static margin of 26%, which allows the aircraft to maintain longitudinal stability for different payload positionings between M2 and M3.

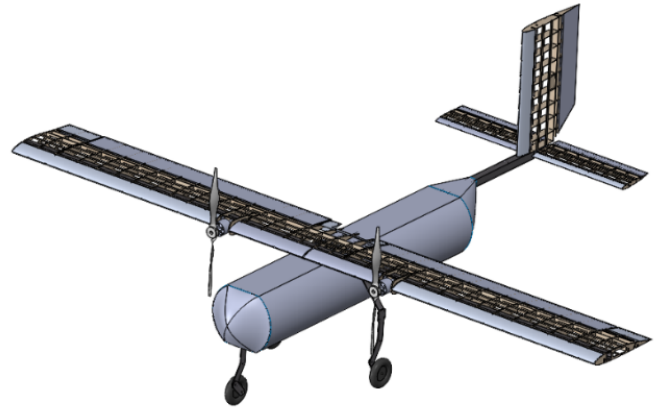

Figure 6: Preliminary Aircraft Design

The propulsion system will consist of 2 motors, mounted on the wings of the aircraft. The main driving factors in the decision were the static thrust and the amount of prop wash generated over the wing. This was primarily due to the 25-foot takeoff limit. The batteries were chosen in accordance with the 100 W-h limit, a 2250 6S2P setup for Mission 2, and a 2700 mAh 5S2P setup for Mission 3. The selected motor is a Scorpion SII-4025-440 kV, the chosen propellers were an 18x11 inch for M2 and a 20x10 inch propeller for M3.

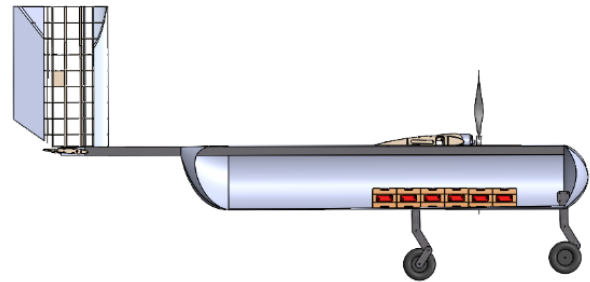

Figure 7: VVP Placement in Fuselage

Six VVPs will be loaded into the front of the fuselage through the removable nose cone of the aircraft. To ensure quick installation of payloads during ground mission, the nose cone of the aircraft will be attached to the fuselage with high strength magnets. During M3, each VVP will be deployed out of the bottom of the fuselage and down an aft facing ramp. After a successful deployment, the remaining VVPs will be moved forward in the fuselage and the next VVP will be stationed above the ramp entrance while the aircraft taxis to the takeoff location. The VVPs are translated through the fuselage with rack and pinions driven by a stepper motor. Each landing gear will have an oil adjustable spring shock damper to mitigate shock on the VVPs during takeoff and landing in M3. For M2, 70 syringes will be placed throughout the entire fuselage through the nose cone and a similarly removable tail cone.

The proposed aircraft configuration can be seen in *Figure 6* and *Figure 7*.

#### 4. MANUFACTURING

The manufacturing plan can be seen in *Figure 8* and is structured such that it allows for independent manufacturing and testing of the main aircraft and systems. Once the manufacturing of the aircraft and testing of the system is completed, propulsion, electronics, and systems will be fully

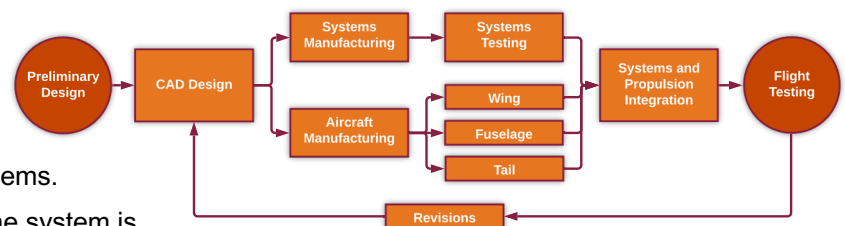

Figure 8: Manufacturing Plan



integrated into the aircraft in preparation for flight testing. When the aircraft design is finalized, the first prototype will be produced. Balsa wood will be used to construct the frames of the wings, stabilizers, and most control surfaces due to its lightweight properties while basswood and plywood will be used for parts that need to be stronger. MonoKote will be used to form the exterior skin of the aerodynamic surfaces to form a semi-monocoque structure. Carbon fiber spars, booms, and in-house composite layups will be used to support the main structural components such as the wing, fuselage, landing gear, and empennage.



Figure 9: Manufactured VVPs

To maintain consistency and quality during the manufacturing process, two dimensional parts such as ribs or shear webs will be fabricated using a laser cutter. Competition compliant VVPs will be used manufactured in house to represent those that will be supplied during the competition and can be seen in Figure 9. Wet composite layups for the fuselage will be completed using two negative foam molds while the nose and tail cone will consist of positive foam molds. Each mold will be cut using a hot wire with a plywood template to ensure the

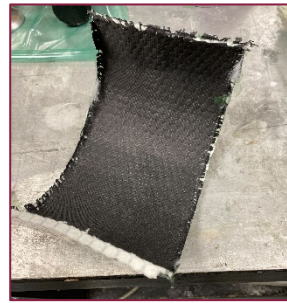

Figure 10: Fuselage Section Inner



Figure 11: Fuselage Section Outer

correct shape is produced. An example section of the composite fuselage is displayed in Figure 10 and Figure 11.

Cyanoacrylate glue will be used to join the wooden structural components which will then be epoxied onto carbon fiber spars. Traditional mechanical fasteners will be used where applicable such as joining the wing to the composite fuselage.

## 5. TESTING PLAN

Each component of the aircraft will be tested to ensure that all safety precautions are followed, and each sub-system operates as expected before the first air vehicle prototype is flown. The entire aircraft will be analyzed using Computational Flow Dynamics (CFD) to verify initial lift and drag analyses. The wing spar and fuselage boom will be subjected to load testing to validate structural integrity and to be compared with FEA. The propulsion configuration will be tested using a team-built thrust stand capable of measuring battery discharge rates simultaneously to confirm endurance calculations. Propulsion testing will be conducted in the static case to validate takeoff distance calculations and in a wind tunnel at varying airspeeds to ensure proper velocity calculations. Shock mitigation and deployment systems will be tested separately from the competition aircraft in a testbed aircraft with similar flight characteristics and aircraft configuration. VVPs will be loaded and deployed to ensure that the 5G limit is not exceeded during M3 deployment.

The aircraft will go through pre-flight checks consisting of center of gravity location, wingtip, control surface deflections, propulsion system, and deployment system tests. The aircraft will then be flown to test takeoff requirements, average mission lap time, in-flight stability and performance, taxi capabilities, and overall mission compliance. Ground mission testing will be conducted to verify payload ease of installation and reliability of the VVP deployment system. The VVPs will be rigorously tested within the aircraft using the deployment system and shock absorbing landing gear. Results from the above-mentioned testing as well as pilot feedback will then be used to make improvements upon the design of the subsequent air vehicles leading up to the final competition aircraft.